

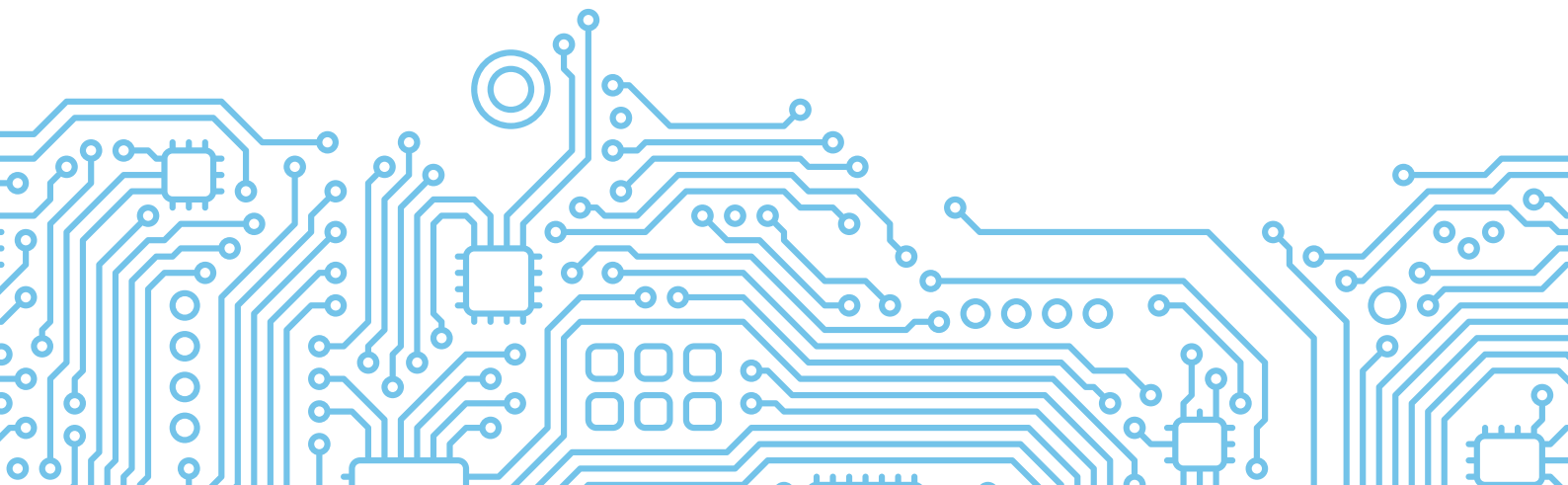

TM_18(GA)_R32_3D INV_EU_NA_1912

18C R32 3D INVERTER CONTROL

2019 TECHNICAL MANUAL

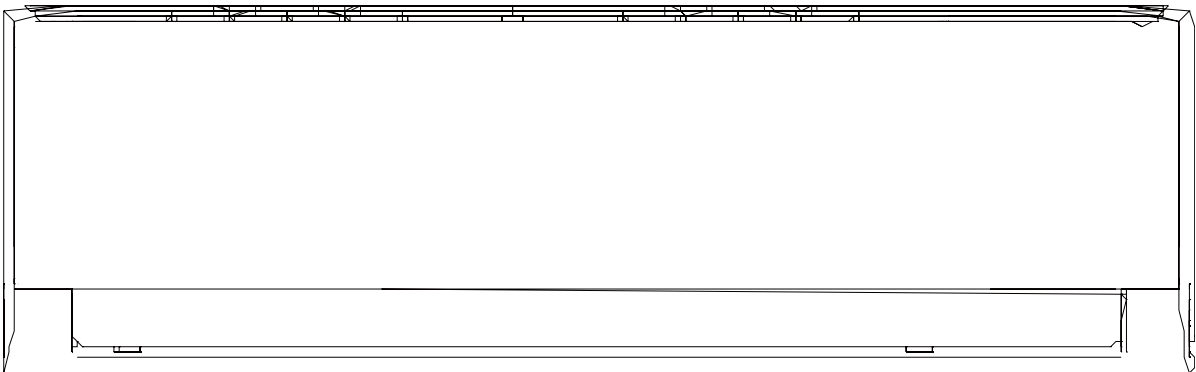

| | |
|---------------------------------------|----|
| 1. Specifications | 3 |
| 1. Model Reference | |
| 2. General Specifications | |
| 3. Dimensional Drawings | |
| 4. Electrical Wiring Diagrams | |
| 5. Refrigerant Cycle Diagrams | |
| 6. Capacity Tables | |
| 7. Noise Criterion Curves | |
| 8. Electrical Characteristics | |
| 2. Product Features | 47 |
| 1. Operation Modes and Functions | |
| 2. Remote Controller Functions | |
| 3. Installation | 60 |
| 1. Installation Overview | |
| 2. Location Selection | |
| 3. Indoor Unit Installation | |
| 4. Outdoor Unit Installation | |
| 5. Refrigerant Pipe Installation | |
| 6. Vacuum Drying and Leakage Checking | |
| 7. Additional Refrigerant Charge | |
| 8. Electrical and Gas Leak Checks | |
| 9. Test Operation | |

Specifications

Contents

| | | |
|----|----------------------------------|----|
| 1. | Model Reference | 4 |
| 2. | General Specifications | 5 |
| 3. | Dimensional Drawings..... | 11 |
| 4. | Electrical Wiring Diagrams..... | 16 |
| 5. | Refrigerant Cycle Diagrams..... | 22 |
| 6. | Capacity Tables | 24 |
| 7. | Noise Criterion Curves | 42 |
| 8. | Electrical Characteristics | 46 |

1. Model Reference

Refer to the following table to determine the specific indoor and outdoor unit model number of your purchased equipment.

| Indoor Unit Model | Outdoor Unit Model | Capacity (Btu/h) | Power Supply |
|-------------------|--------------------|------------------|------------------------|
| 42QHG007D8S* | 38QHG007D8S* | 7K | 1Φ, 220~240V~, 50/60Hz |
| 42QHG009D8S* | 38QHG009D8S* | 9K | |
| 42QHG009D8SH | 38QHG009D8SH | | |
| 42QHG012D8S* | 38QHG012D8S* | 12k | |
| 42QHG012D8SH | 38QHG012D8SH | | |
| 42QHG018D8S* | 38QHG018D8S* | 18K | |
| 42QHG022D8S | 38QHG022D8S | 22K | |
| 42QHG024D8S* | 38QHG024D8S* | 24K | |

2. General Specifications

| Outdoor Unit | | 38QHGG007D8S* | 38QHGG009D8S* | 38QHGG012D8S* | 38QHGG018D8S* | 38QHGG022D8S* | 38QHGG024D8S* |
|-------------------------------------|----------|-------------------------|-------------------------|-------------------------|-------------------------|-------------------------|-------------------------|
| Cooling Capacity | kW | 2.05(1.0-3.2) | 2.75(1.0-3.2) | 3.65(1.4-4.3) | 5.28(3.4-5.9) | 6.25(2.1-8.2) | 7.04(2.1-8.2) |
| Heating Capacity | kW | 2.75(0.8-3.4) | 2.90(0.8-3.4) | 3.90(1.1-4.4) | 5.70(3.1-5.8) | 7.24(1.5-8.2) | 7.50(1.5-8.2) |
| Heating Capacity at -7°C | kW | 2.50 | 2.50 | 2.70 | 4.30 | 5.80 | 5.80 |
| Heating Capacity at -10°C | kW | 2.00 | 2.00 | 2.10 | 3.50 | 5.50 | 5.50 |
| Heating Capacity at -15°C | kW | 1.65 | 1.65 | 1.70 | 2.50 | 4.50 | 4.50 |
| P design capacity cooling | kW | 2.05 | 2.75 | 3.65 | 5.28 | 6.25 | 7.04 |
| P design capacity heating(warmer) | kW | 2.50 | 2.50 | 2.50 | 4.50 | 6.40 | 6.40 |
| P design capacity heating(average) | kW | 2.50 | 2.50 | 2.50 | 4.10 | 5.20 | 5.20 |
| Temp range cooling | °C | -15~50 | -15~50 | -15~50 | -15~50 | -15~50 | -15~50 |
| Temp range heating | °C | -15~24 | -15~24 | -15~24 | -15~24 | -15~24 | -15~24 |
| SEER / SCOP(warmer) / SCOP(average) | W/W | 7.4 / 5.2 / 4.0 | 7.4 / 5.3 / 4.1 | 7.0 / 5.5 / 4.2 | 7.0 / 5.1 / 4.0 | 6.6 / 5.1 / 4.0 | 6.5 / 5.1 / 4.0 |
| Energy label | | A++ / A+++ / A+ | A++ / A+++ / A+ | A++ / A+++ / A+ | A++ / A+++ / A+ | A++ / A+++ / A+ | A++ / A+++ / A+ |
| Yearly energy consumption | kWh | 97 / 673 / 875 | 130 / 660 / 854 | 182 / 636 / 833 | 264 / 1235 / 1435 | 331 / 1757 / 1820 | 379 / 1757 / 1820 |
| EER/COP | W/W | 4.02 / 4.01 | 3.59 / 3.85 | 3.23 / 3.71 | 3.40 / 3.35 | 3.25 / 3.74 | 2.82 / 3.41 |
| Voltage, Hz | | 220-240V~, 50/60Hz | 220-240V~, 50/60Hz | 220-240V~, 50/60Hz | 220-240V~, 50/60Hz | 220-240V~, 50/60Hz | 220-240V~, 50/60Hz |
| Standard current (cooling) | A | 2.30 | 3.50 | 5.00 | 6.80 | 10.90 | 10.90 |
| Standard input (cooling) | W | 510 | 765 | 1130 | 1550 | 2500 | 2500 |
| Standard current (heating) | A | 3.00 | 3.40 | 4.60 | 7.40 | 9.60 | 9.60 |
| Standard input (heating) | W | 685 | 760 | 1050 | 1700 | 2200 | 2200 |
| Rated current | A | 10.0 | 10.0 | 10.0 | 13.0 | 19.0 | 19.0 |
| Rated input | W | 2150 | 2150 | 2150 | 2500 | 3700 | 3700 |
| Refrigerant amount | kg | 0.30 | 0.60 | 0.65 | 1.10 | 1.45 | 1.45 |
| Compressor model | | KSK103D33UEZ3 | KSK103D33UEZ3 | KSK103D33UEZ3 | KSN140D21UFZ | KTM240D57UMT | KTM240D57UMT |
| Refrigerant oil/oil quantity | ml | ESTER OIL VG74 280±5 | ESTER OIL VG74 280±5 | ESTER OIL VG74 280±5 | ESTER OIL VG74 440±15 | ESTER OIL VG74 670±15 | ESTER OIL VG74 670±15 |
| Liquid side/Gas side | mm(inch) | Φ6.35/Φ9.52 (1/4"/3/8") | Φ6.35/Φ9.52 (1/4"/3/8") | Φ6.35/Φ9.52 (1/4"/3/8") | Φ6.35/Φ12.7 (1/4"/1/2") | Φ9.52/Φ15.9 (3/8"/5/8") | Φ9.52/Φ15.9 (3/8"/5/8") |
| Standard piping length | m | 5 | 5 | 5 | 5 | 5 | 5 |
| Min piping length | m | 3 | 3 | 3 | 3 | 3 | 3 |
| Max piping length | m | 25 | 25 | 25 | 30 | 40 | 30 |
| Max difference | m | 10 | 10 | 10 | 20 | 20 | 20 |
| Additional charge | g/m | 12 | 12 | 12 | 12 | 24 | 24 |

| INDOOR UNIT | | 42QHGG007D8S* | 42QHGG009D8S* | 42QHGG012D8S* | 42QHGG018D8S* | 42QHGG022D8S* | 42QHGG024D8S* |
|------------------------------------|-------|---------------|---------------|---------------|---------------|---------------|---------------|
| Indoor fan motor Input | W | 22 | 22 | 20 | 36 | 60 | 60 |
| Indoor fan motor max current | A | 0.5 | 0.5 | 0.5 | 0.5 | 0.7 | 0.7 |
| Sound power level | dB(A) | 56 | 56 | 56 | 58 | 63 | 63 |
| Sound pressure level (Min. ~ Max.) | dB(A) | 20~37 | 20~37 | 20~37 | 21~41 | 22~47 | 22~47 |
| Air flow(Min. ~ Max.) | m3/h | 180~460 | 180~460 | 195~530 | 300~800 | 480~1090 | 480~1090 |
| Weight (Net/Gross) | kg | 8.0/10.5 | 8.0/10.5 | 8.7/11.5 | 11.2 / 14.6 | 13.6 / 17.3 | 13.6 / 17.3 |
| Dimensions (WxDxH) | mm | 726x210x291 | 726x210x291 | 835x208x295 | 969x241x320 | 1083x244x336 | 1083x244x336 |
| Packing (WxDxH) | mm | 790x270x375 | 790x270x375 | 905x290x355 | 1045x315x405 | 1155x315x415 | 1155x315x415 |

| OUTDOOR UNIT | | 38QHGG007D8S* | 38QHGG009D8S* | 38QHGG012D8S* | 38QHGG018D8S* | 38QHGG022D8S* | 38QHGG024D8S* |
|----------------------|-------|---------------|---------------|---------------|---------------|---------------|---------------|
| Sound power level | dB(A) | 63 | 63 | 64 | 65 | 69 | 69 |
| Sound pressure level | dB(A) | 55.5 | 55.5 | 56 | 57 | 60 | 60 |
| Airflow | m3/h | 1750 | 1750 | 1800 | 2100 | 3500 | 3500 |
| Weight (Net/Gross) | kg | 23.5/25.4 | 23.5/25.4 | 23.7/25.5 | 33.5 / 36.1 | 43.9 / 46.9 | 43.9 / 46.9 |
| Dimensions (WxDxH) | mm | 720x270x495 | 720x270x495 | 720x270x495 | 805x330x554 | 890x342x673 | 890x342x673 |
| Packing (WxDxH) | mm | 835x300x540 | 835x300x540 | 835x300x540 | 915x370x615 | 995x398x740 | 995x398x740 |

Notes: 1) Sound data @ cooling mode 2) -7/-15/-20°C heating @ free frequency

| Outdoor Unit | | 38QH009D8SH | 38QH012D8SH |
|-------------------------------------|----------|-------------------------|-------------------------|
| Cooling Capacity | kW | 2.64 (1.03-3.22) | 3.36(1.38~4.31) |
| Heating Capacity | kW | 2.85 (0.82-3.37) | 3.81(1.07~4.38) |
| Heating Capacity at -7°C | kW | | |
| Heating Capacity at -10°C | kW | | |
| Heating Capacity at -15°C | kW | | |
| P design capacity cooling | kW | 2.64 | 3.36 |
| P design capacity heating(warmer) | kW | 2.50 | 2.60 |
| P design capacity heating(average) | kW | 2.60 | 2.60 |
| Temp range cooling | °C | -15~50 | -15~50 |
| Temp range heating | °C | -15~24 | -15~24 |
| SEER / SCOP(warmer) / SCOP(average) | W/W | 8.5 / 5.4 / 4.2 | 8.5 / 5.8 / 4.3 |
| Energy label | | A+++ / A+++ / A+ | A+++ / A+++ / A+ |
| Yearly energy consumption | kWh | 109 / 648 / 867 | 138 / 628 / 846 |
| EER/COP | W/W | 4.00 / 4.07 | 3.91 / 3.93 |
| Voltage, Hz | | 220-240V~, 50/60Hz | 220-240V~, 50/60Hz |
| Standard current (cooling) | A | 2.90 | 3.80 |
| Standard input (cooling) | W | 660 | 860 |
| Standard current (heating) | A | 3.10 | 4.40 |
| Standard input (heating) | W | 700 | 1000 |
| Rated current | A | 10.0 | 10.0 |
| Rated input | W | 2150 | 2150 |
| Refrigerant amount | kg | 0.62 | 0.62 |
| Compressor model | | KSN98D22UFZ | KSN98D22UFZ |
| Refrigerant oil/oil quantity | ml | ESTER OIL RB74AF 370 | ESTER OIL RB74AF 370 |
| Liquid side/Gas side | mm(inch) | Ø6.35/Ø9.52 (1/4"/3/8") | Ø6.35/Ø9.52 (1/4"/3/8") |
| Standard piping length | m | 5 | 5 |
| Min piping length | m | 3 | 3 |
| Max piping length | m | 25 | 25 |
| Max difference | m | 10 | 10 |
| Additional charge | g/m | 12 | 12 |

| INDOOR UNIT | | 42QH009D8SH | 42QH012D8SH |
|------------------------------------|-------|-------------|-------------|
| Indoor fan motor Input | W | 20 | 20 |
| Indoor fan motor max current | A | 0.5 | 0.5 |
| Sound power level | dB(A) | 57 | 60 |
| Sound pressure level (Min. ~ Max.) | dB(A) | 21~37 | 21~38 |
| Air flow(Min. ~ Max.) | m3/h | 160~510 | 170~520 |
| Weight (Net/Gross) | kg | 8.7/11.5 | 8.7/11.3 |
| Dimensions (WxDxH) | mm | 835x208x295 | 835x208x295 |
| Packing (WxDxH) | mm | 905x290x355 | 905x290x355 |

| OUTDOOR UNIT | | 38QH009D8SH | 38QH012D8SH |
|----------------------|-------|-------------|-------------|
| Sound power level | dB(A) | 61 | 65 |
| Sound pressure level | dB(A) | 54 | 55 |
| Airflow | m3/h | 2150 | 2200 |
| Weight (Net/Gross) | kg | 26.2/28.8 | 26.4/28.8 |
| Dimensions (WxDxH) | mm | 765x303x555 | 765x303x555 |
| Packing (WxDxH) | mm | 887x337x610 | 887x337x610 |

Notes:

- 1) Sound data @ cooling mode
- 2) -7/-15/-20°C heating @ free frequency

3. Dimensional Drawings

3.1 Indoor Unit

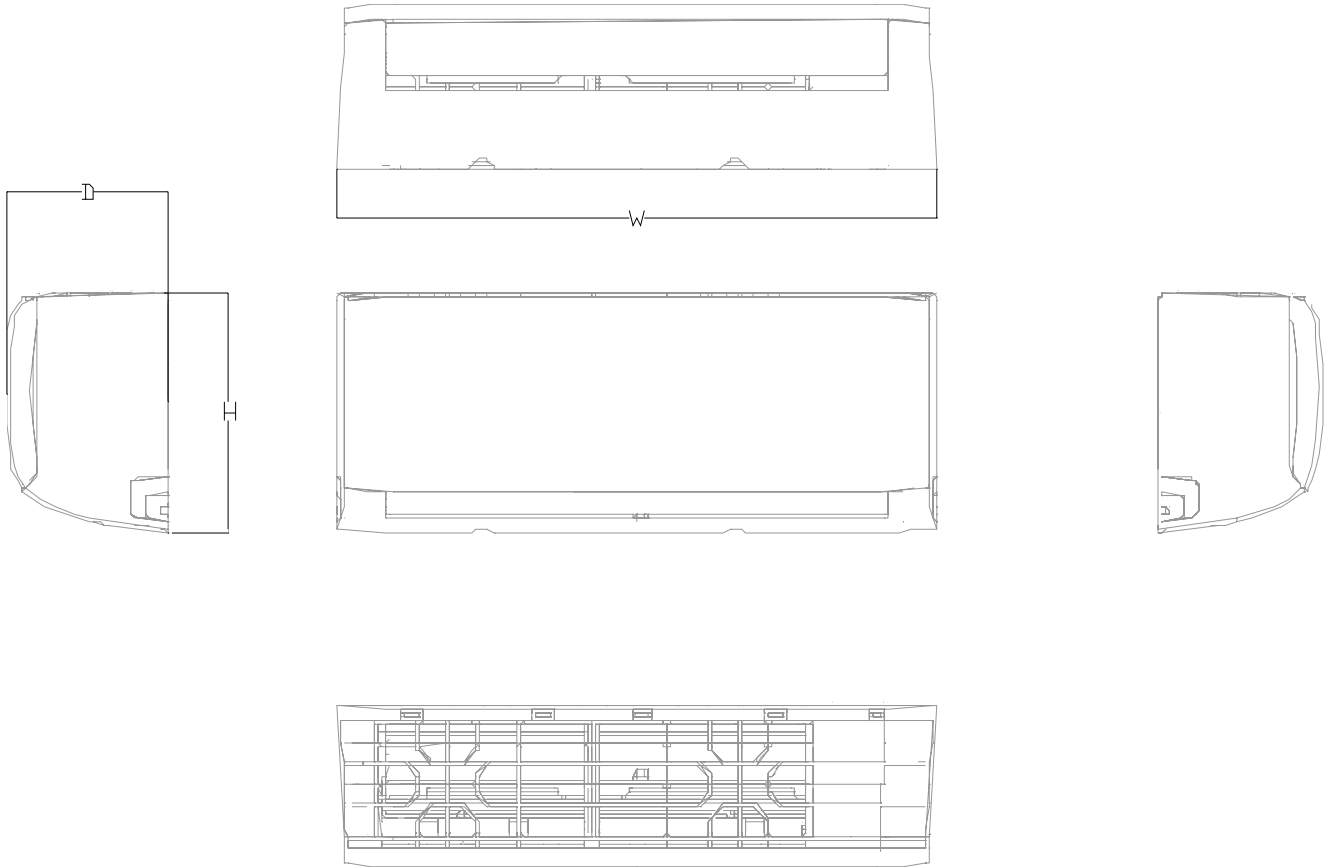

| Model | W(mm) | D(mm) | H(mm) |
|--------------|-------|-------|-------|
| 42QHG007D85* | 726 | 210 | 291 |
| 42QHG009D85* | 726 | 210 | 291 |
| 42QHG009D8SH | 835 | 208 | 295 |
| 42QHG012D85* | 835 | 208 | 295 |
| 42QHG012D8SH | 835 | 208 | 295 |
| 42QHG018D85* | 969 | 241 | 320 |
| 42QHG022D85* | 1083 | 244 | 336 |
| 42QHG024D85* | 1083 | 244 | 336 |

3.2 Outdoor Unit

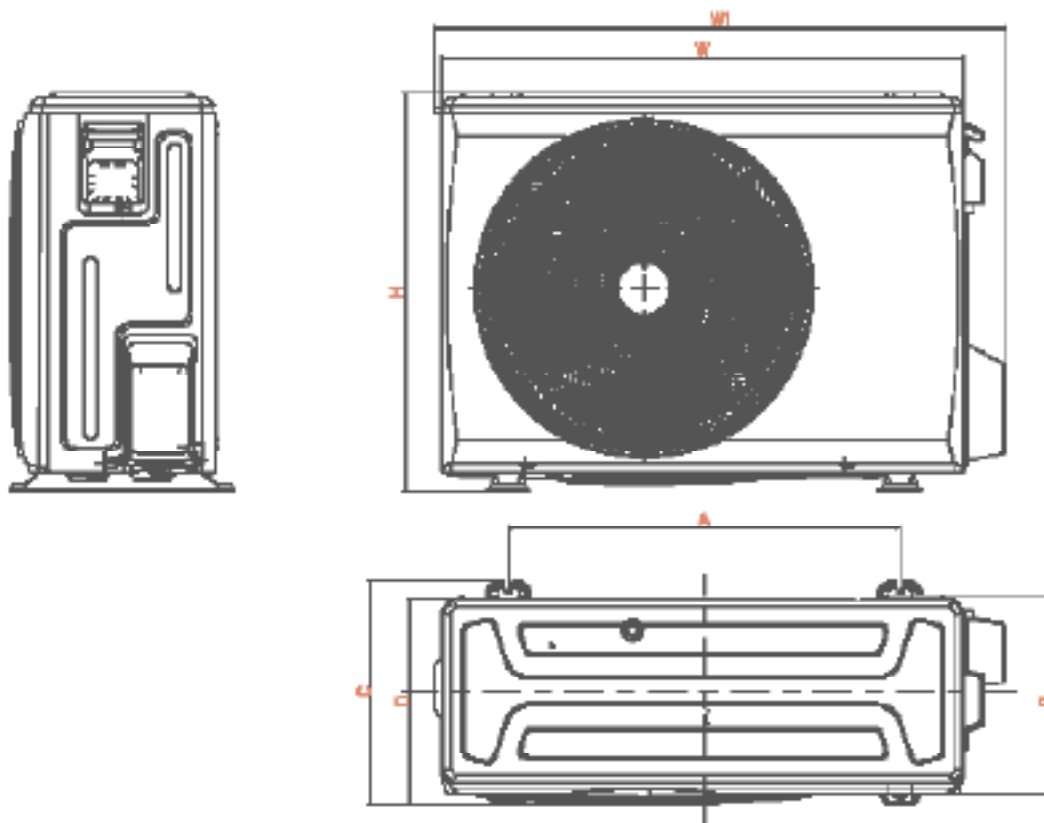

| Model | W(mm) | D(mm) | H(mm) | W1(mm) | A(mm) | B(mm) | C(mm) |
|-------------|-------|-------|-------|--------|-------|-------|-------|
| 38QH007D85* | 720 | 270 | 495 | 792 | 452 | 255 | 280 |
| 38QH009D85* | 720 | 270 | 495 | 792 | 452 | 255 | 280 |
| 38QH009D85H | 765 | 300 | 555 | 835 | 452 | 286 | 310 |
| 38QH012D85H | 765 | 300 | 555 | 835 | 452 | 286 | 310 |
| 38QH018D85* | 800 | 333 | 554 | 870 | 511 | 318 | 344 |
| 38QH022D85* | 884 | 356 | 673 | 957 | 663 | 338 | 380 |
| 38QH024D85* | 884 | 356 | 673 | 957 | 663 | 338 | 380 |

4. Electrical Wiring Diagrams

4.1 Indoor unit

| Abbreviation | Paraphrase |
|--------------|---|
| Y/G | Yellow-Green Conductor |
| ION | Positive and Negative Ion Generator |
| CAP | Capacitor |
| PLASMA | Electronic Dust Collector |
| L | LIVE |
| N | NEUTRAL |
| T1 | Indoor Room Temperature |
| T2 | Coil Temperature of Indoor Heat Exchanger |

42QHG007D85*, 42QHG009D85*, 42QHG009D8SH, 42QHG012D85*, 42QHG012D8SH, 42QHG018D85*

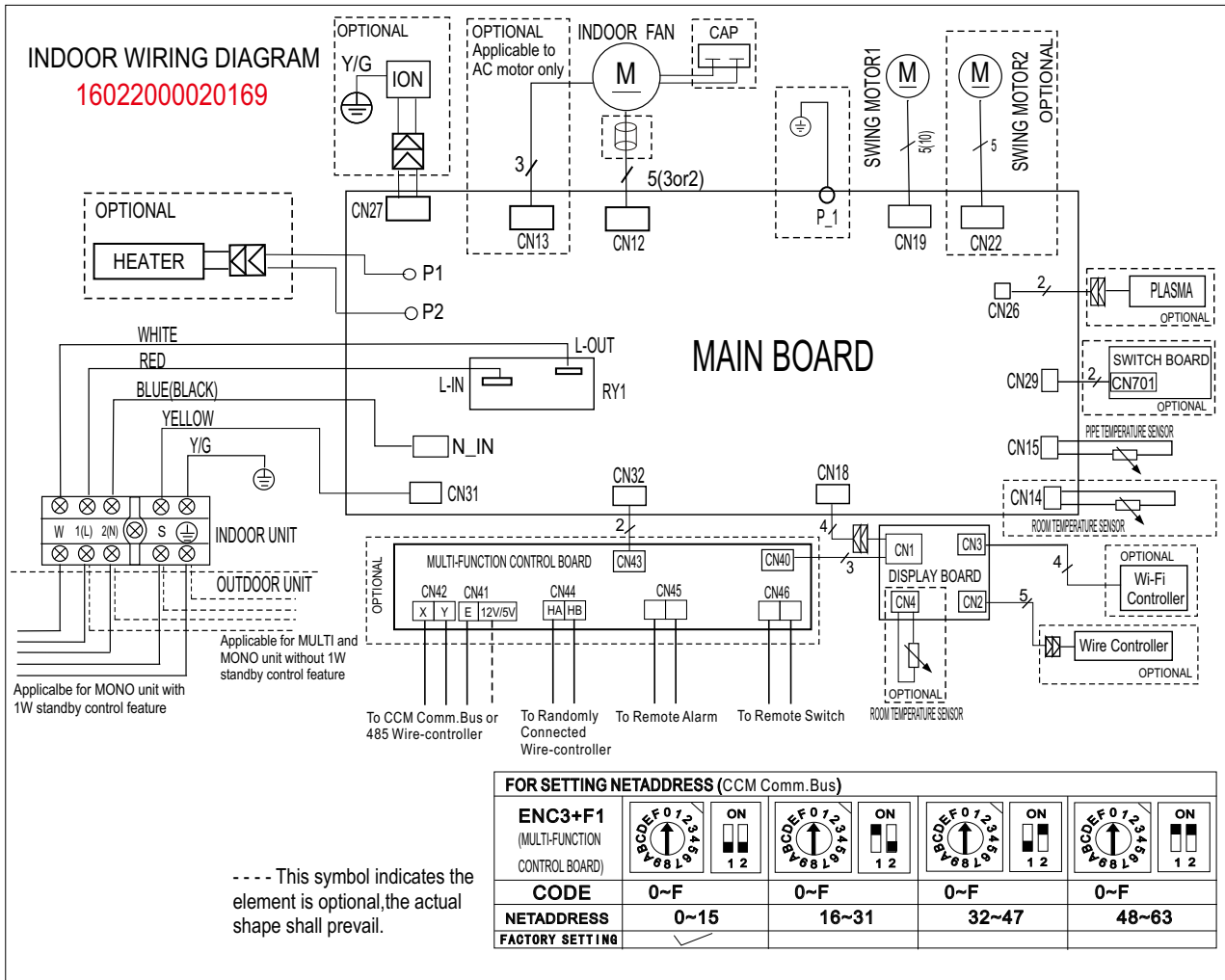

42QHG022D8S*, 42QHG024D8S*

16022000003662

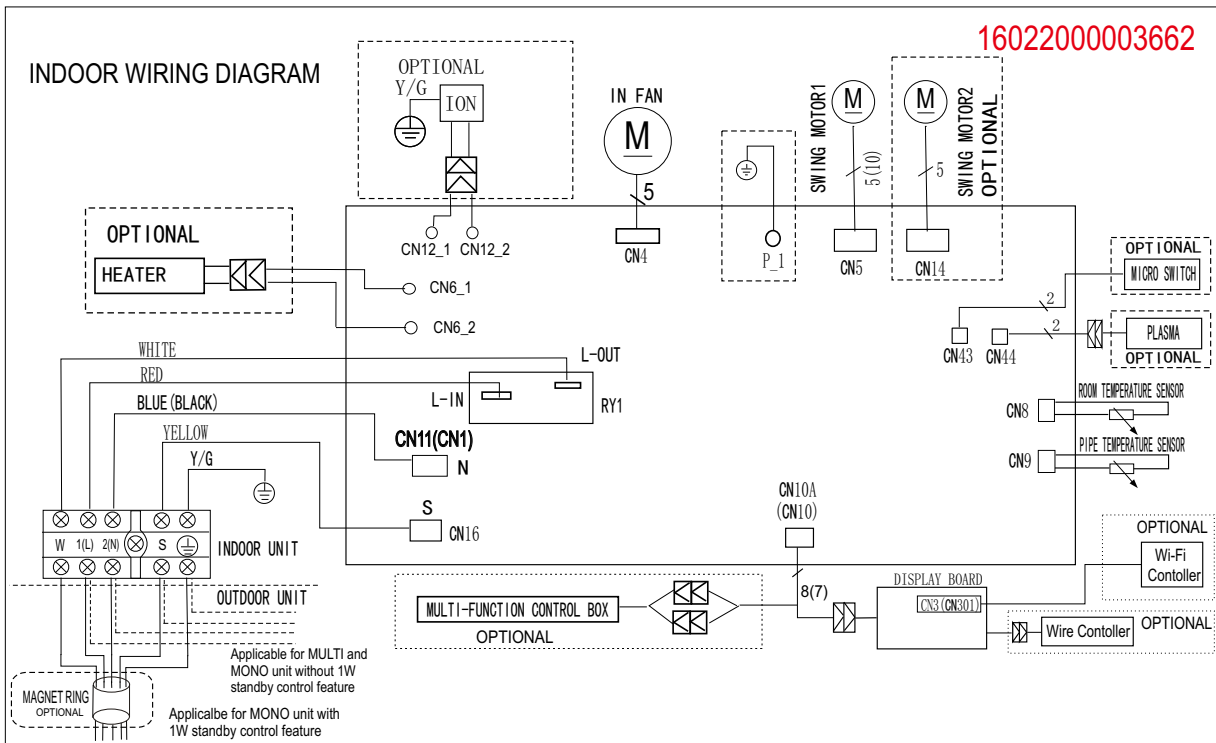

Specifications

4.2 Outdoor Unit

| Abbreviation | Paraphrase |
|--------------|--------------------------------|
| 4-WAY | Gas Valve Assembly/4-WAY VALVE |
| AC-FAN | Alternating Current FAN |
| DC-FAN | Direct Current FAN |
| COMP | Compressor |

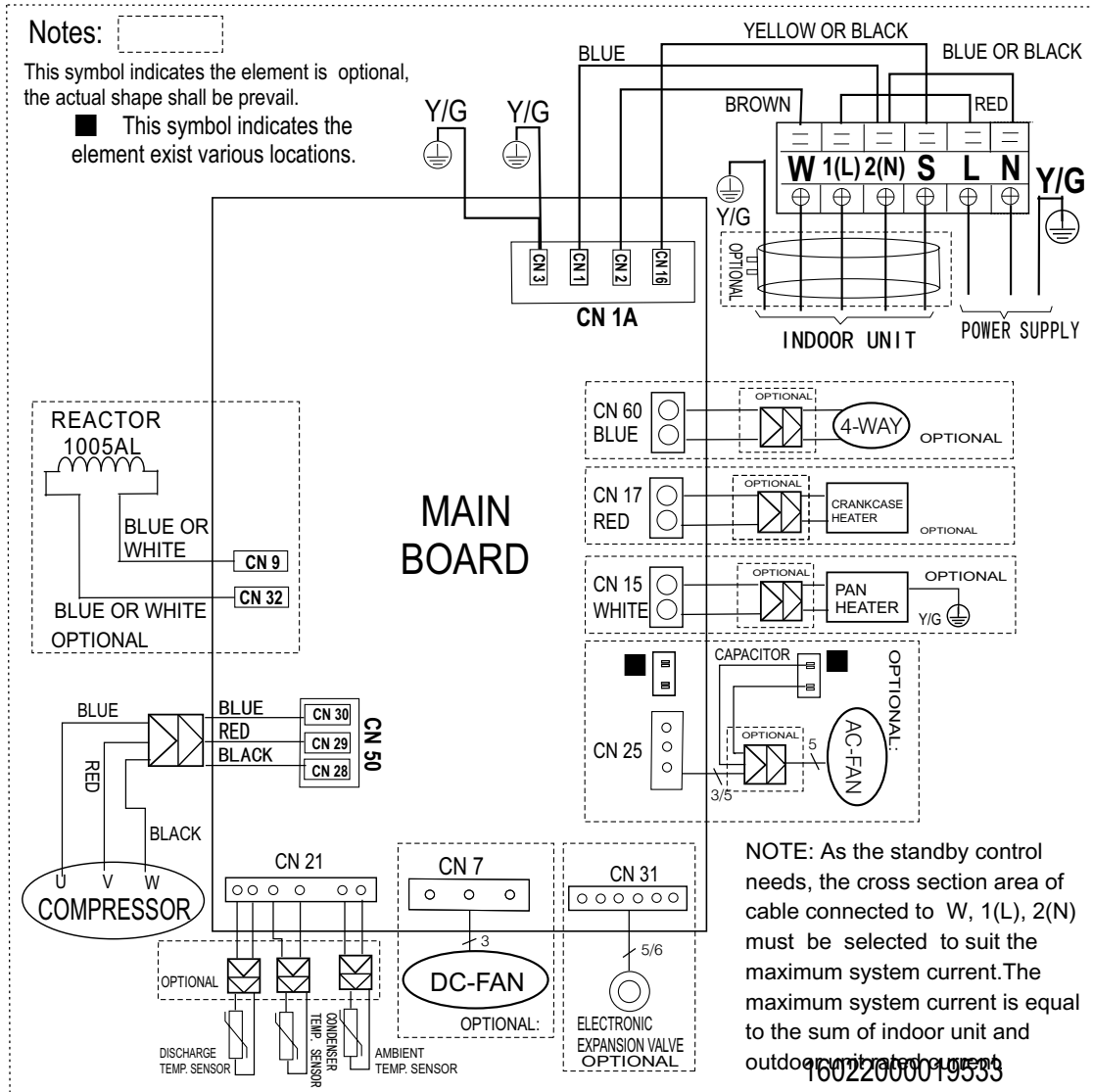

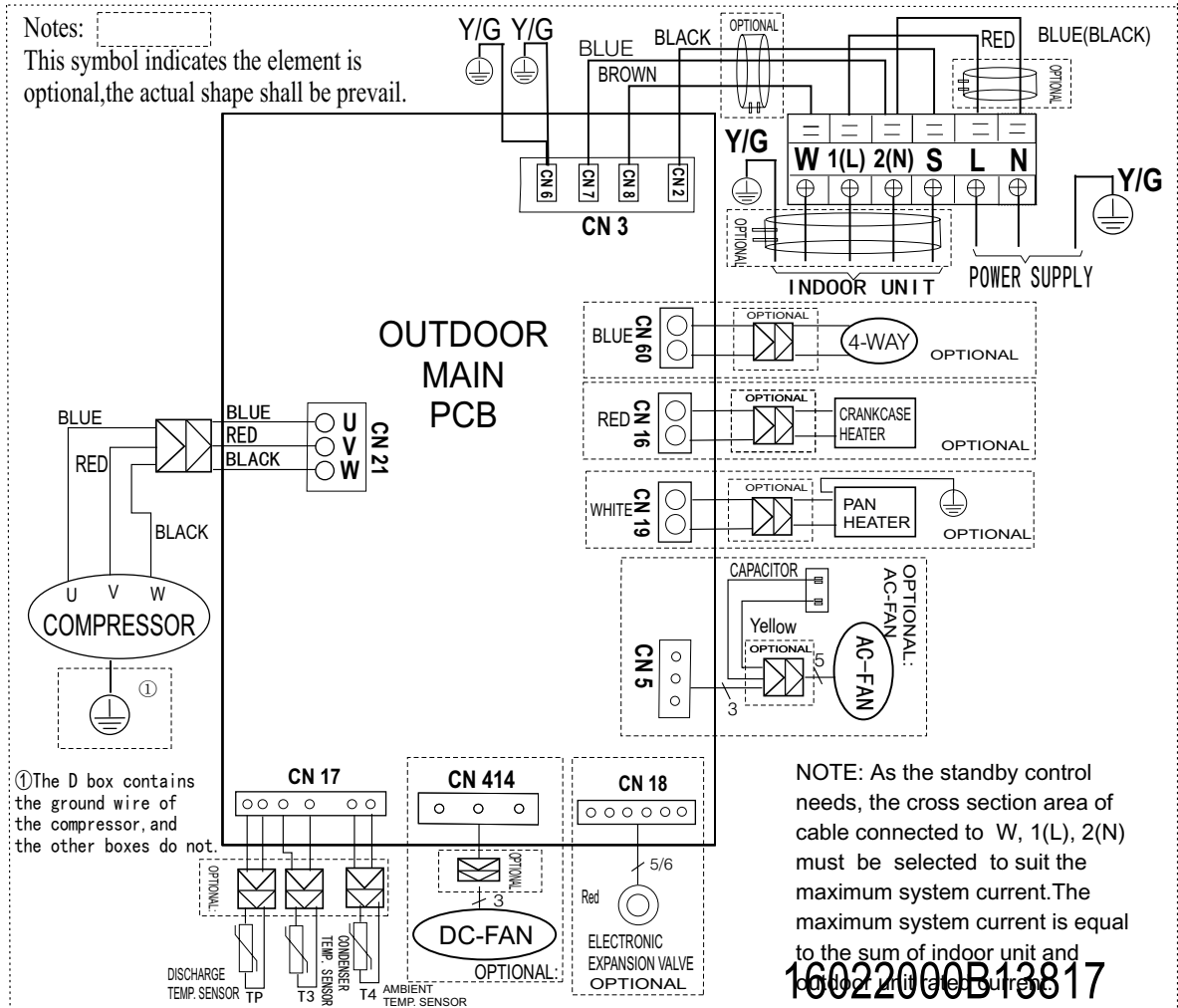

5. Refrigerant Cycle Diagrams

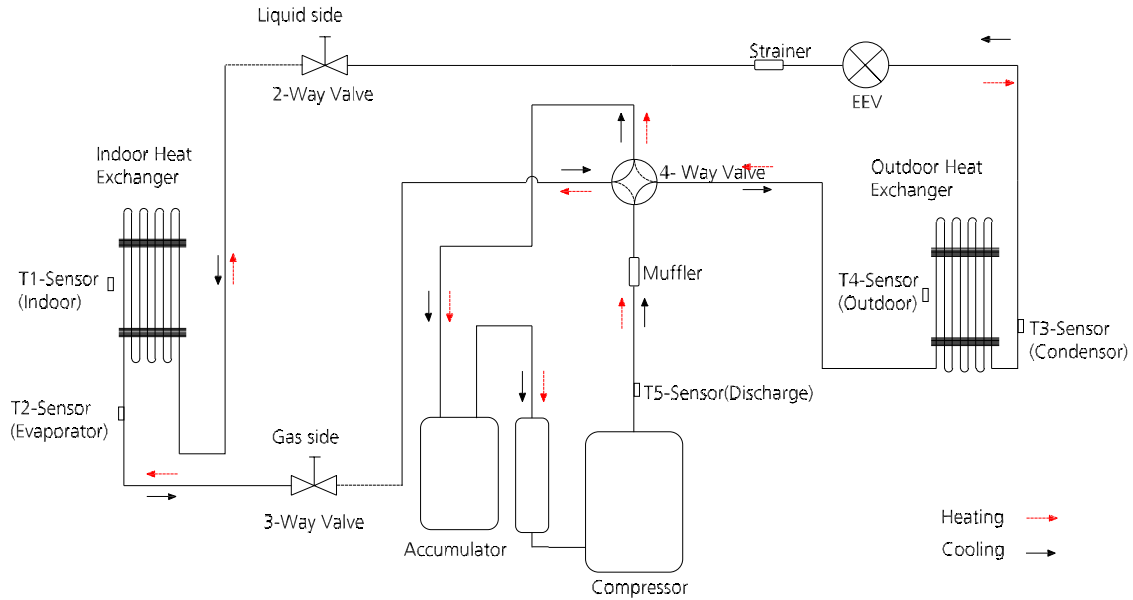

| Model | Pipe Size (Diameter:ø) mm(inch) | | Piping length (m/ft) | | Elevation (m/ft) | | Additional Refrigerant |
|--------------|------------------------------------|-----------|----------------------|---------|------------------|---------|------------------------|
| | Gas | Liquid | Rated | Max. | Rated | Max. | |
| 38QHG007D8S* | 9.52(3/8) | 6.35(1/4) | 5/16.4 | 25/82 | 0 | 10/32.8 | 12g/m (0.13oz/ft) |
| 38QHG009D8S* | | | | | | | |
| 38QHG009D8SH | | | | | | | |
| 38QHG012D8S* | | | | | | | |
| 38QHG018D8S* | 12.7(1/2) | 6.35(1/4) | 5/16.4 | 30/98.4 | 0 | 20/65.6 | 24g/m (0.26oz/ft) |
| 38QHG022D8S* | 15.9(5/8) | 9.52(3/8) | 5/16.4 | 30/98.4 | 0 | 20/65.6 | |
| 38QHG024D8S | | | | | | | |

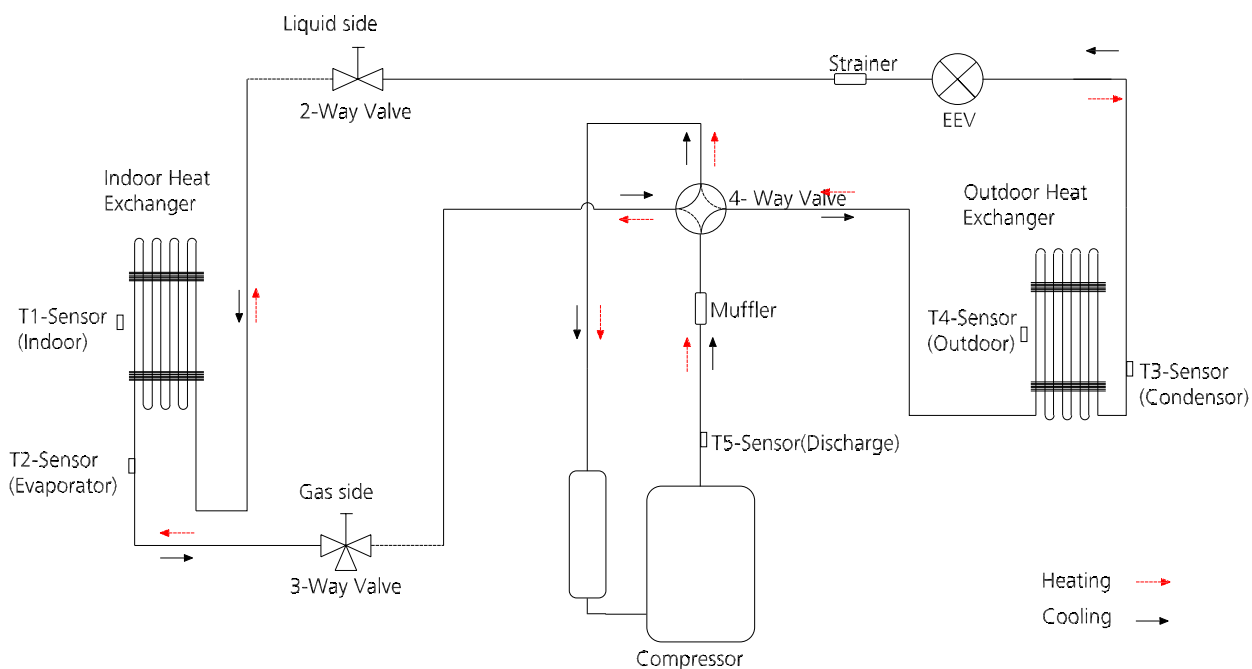

| Model | Pipe Size (Diameter:ø) mm(inch) | | Piping length (m/ft) | | Elevation (m/ft) | | Additional Refrigerant |
|--------------|------------------------------------|-----------|----------------------|-------|------------------|---------|------------------------|
| | Gas | Liquid | Rated | Max. | Rated | Max. | |
| 38QHG012D8SH | 9.52(3/8) | 6.35(1/4) | 5/16.4 | 25/82 | 0 | 10/32.8 | 12g/m (0.13oz/ft) |

6. Capacity Tables

6.1 Cooling

| 42QHG009D8S+38QHG009D8S | | | | | | | | | | | | | | | | | | |
|-------------------------|---------------|-----------|------|------|------|------|------|------|------|------|------|------|------|------|------|------|------|------|
| INDOOR AIRFLOW (CMH) | OUTDOOR DB(C) | ID WB (C) | 16.0 | | | | 18.0 | | | | 19.0 | | | | 22.0 | | | |
| | | ID DB (C) | 23.0 | 25.0 | 27.0 | 30.0 | 23.0 | 25.0 | 27.0 | 30.0 | 23.0 | 25.0 | 27.0 | 30.0 | 23.0 | 25.0 | 27.0 | 30.0 |
| 260 | -15 | TC | 2.75 | 2.73 | 2.73 | 2.73 | 2.89 | 2.95 | 2.95 | 2.95 | 2.97 | 2.97 | 2.97 | 2.97 | 3.14 | 3.14 | 3.14 | 3.14 |
| | | S/T | 0.66 | 0.72 | 0.79 | 0.86 | 0.55 | 0.61 | 0.67 | 0.73 | 0.49 | 0.55 | 0.61 | 0.68 | 0.38 | 0.42 | 0.48 | 0.54 |
| | | PI | 0.49 | 0.49 | 0.49 | 0.49 | 0.49 | 0.49 | 0.49 | 0.49 | 0.49 | 0.49 | 0.49 | 0.49 | 0.49 | 0.49 | 0.49 | 0.49 |
| | -10 | TC | 2.73 | 2.72 | 2.72 | 2.72 | 2.87 | 2.94 | 2.94 | 2.94 | 2.95 | 2.95 | 2.95 | 2.95 | 3.13 | 3.13 | 3.13 | 3.13 |
| | | S/T | 0.66 | 0.73 | 0.80 | 0.86 | 0.55 | 0.61 | 0.67 | 0.74 | 0.49 | 0.55 | 0.61 | 0.68 | 0.38 | 0.43 | 0.49 | 0.54 |
| | | PI | 0.49 | 0.49 | 0.49 | 0.49 | 0.49 | 0.49 | 0.49 | 0.49 | 0.49 | 0.49 | 0.49 | 0.49 | 0.49 | 0.49 | 0.49 | 0.49 |
| | -5 | TC | 2.71 | 2.70 | 2.70 | 2.70 | 2.86 | 2.92 | 2.92 | 2.92 | 2.94 | 2.94 | 2.94 | 2.94 | 3.12 | 3.12 | 3.12 | 3.12 |
| | | S/T | 0.66 | 0.73 | 0.80 | 0.87 | 0.56 | 0.62 | 0.67 | 0.74 | 0.50 | 0.56 | 0.61 | 0.68 | 0.38 | 0.43 | 0.49 | 0.55 |
| | | PI | 0.49 | 0.49 | 0.49 | 0.49 | 0.49 | 0.49 | 0.49 | 0.49 | 0.49 | 0.49 | 0.49 | 0.49 | 0.49 | 0.49 | 0.49 | 0.49 |
| | 0 | TC | 2.70 | 2.69 | 2.69 | 2.69 | 2.85 | 2.91 | 2.91 | 2.91 | 2.93 | 2.93 | 2.93 | 2.93 | 3.12 | 3.12 | 3.12 | 3.12 |
| | | S/T | 0.67 | 0.74 | 0.80 | 0.87 | 0.56 | 0.62 | 0.68 | 0.74 | 0.50 | 0.56 | 0.62 | 0.69 | 0.38 | 0.43 | 0.49 | 0.55 |
| | | PI | 0.49 | 0.49 | 0.49 | 0.49 | 0.49 | 0.49 | 0.49 | 0.49 | 0.49 | 0.49 | 0.49 | 0.49 | 0.49 | 0.49 | 0.49 | 0.49 |
| | 5 | TC | 2.69 | 2.68 | 2.68 | 2.68 | 2.84 | 2.90 | 2.90 | 2.90 | 2.92 | 2.92 | 2.92 | 2.92 | 3.11 | 3.11 | 3.11 | 3.11 |
| | | S/T | 0.67 | 0.74 | 0.81 | 0.88 | 0.56 | 0.62 | 0.68 | 0.75 | 0.50 | 0.56 | 0.62 | 0.69 | 0.38 | 0.43 | 0.49 | 0.55 |
| | | PI | 0.49 | 0.49 | 0.49 | 0.49 | 0.49 | 0.49 | 0.49 | 0.49 | 0.49 | 0.49 | 0.49 | 0.49 | 0.50 | 0.50 | 0.50 | 0.50 |
| | 10 | TC | 2.67 | 2.66 | 2.66 | 2.66 | 2.83 | 2.89 | 2.89 | 2.89 | 2.91 | 2.91 | 2.91 | 2.91 | 3.11 | 3.11 | 3.11 | 3.11 |
| | | S/T | 0.67 | 0.74 | 0.81 | 0.88 | 0.56 | 0.62 | 0.68 | 0.75 | 0.50 | 0.56 | 0.62 | 0.69 | 0.39 | 0.44 | 0.50 | 0.55 |
| | | PI | 0.50 | 0.50 | 0.50 | 0.50 | 0.50 | 0.50 | 0.50 | 0.50 | 0.50 | 0.50 | 0.50 | 0.50 | 0.50 | 0.50 | 0.50 | 0.50 |
| | 15 | TC | 2.65 | 2.64 | 2.64 | 2.64 | 2.81 | 2.87 | 2.87 | 2.87 | 2.89 | 2.89 | 2.89 | 2.89 | 3.09 | 3.09 | 3.09 | 3.09 |
| | | S/T | 0.68 | 0.75 | 0.82 | 0.89 | 0.57 | 0.63 | 0.69 | 0.76 | 0.51 | 0.57 | 0.63 | 0.70 | 0.39 | 0.44 | 0.50 | 0.56 |
| | | PI | 0.51 | 0.51 | 0.51 | 0.51 | 0.51 | 0.51 | 0.51 | 0.51 | 0.51 | 0.51 | 0.51 | 0.51 | 0.51 | 0.51 | 0.51 | 0.51 |
| | 20 | TC | 2.62 | 2.61 | 2.61 | 2.61 | 2.78 | 2.78 | 2.78 | 2.78 | 2.87 | 2.87 | 2.87 | 2.87 | 3.07 | 3.07 | 3.07 | 3.07 |
| | | S/T | 0.68 | 0.75 | 0.82 | 0.89 | 0.57 | 0.63 | 0.69 | 0.76 | 0.51 | 0.57 | 0.63 | 0.70 | 0.39 | 0.44 | 0.50 | 0.56 |
| | | PI | 0.53 | 0.53 | 0.53 | 0.53 | 0.53 | 0.53 | 0.53 | 0.53 | 0.53 | 0.53 | 0.53 | 0.53 | 0.53 | 0.53 | 0.53 | 0.53 |
| | 25 | TC | 2.49 | 2.49 | 2.49 | 2.52 | 2.67 | 2.67 | 2.67 | 2.67 | 2.72 | 2.72 | 2.72 | 2.72 | 2.95 | 2.95 | 2.95 | 2.95 |
| | | S/T | 0.69 | 0.76 | 0.83 | 0.90 | 0.57 | 0.63 | 0.70 | 0.76 | 0.51 | 0.58 | 0.64 | 0.70 | 0.38 | 0.44 | 0.50 | 0.56 |
| | | PI | 0.59 | 0.59 | 0.59 | 0.59 | 0.59 | 0.59 | 0.59 | 0.59 | 0.59 | 0.59 | 0.59 | 0.59 | 0.59 | 0.59 | 0.59 | 0.59 |
| | 30 | TC | 2.38 | 2.38 | 2.38 | 2.41 | 2.52 | 2.52 | 2.52 | 2.52 | 2.61 | 2.61 | 2.61 | 2.61 | 2.81 | 2.81 | 2.81 | 2.81 |
| | | S/T | 0.70 | 0.77 | 0.84 | 0.91 | 0.57 | 0.64 | 0.71 | 0.78 | 0.51 | 0.58 | 0.65 | 0.71 | 0.38 | 0.44 | 0.50 | 0.56 |
| | | PI | 0.64 | 0.64 | 0.64 | 0.64 | 0.65 | 0.65 | 0.65 | 0.65 | 0.65 | 0.65 | 0.65 | 0.65 | 0.65 | 0.65 | 0.65 | 0.65 |
| | 35 | TC | 2.26 | 2.26 | 2.26 | 2.29 | 2.41 | 2.41 | 2.41 | 2.41 | 2.49 | 2.49 | 2.49 | 2.49 | 2.67 | 2.67 | 2.67 | 2.67 |
| | | S/T | 0.70 | 0.78 | 0.85 | 0.93 | 0.57 | 0.64 | 0.72 | 0.79 | 0.51 | 0.58 | 0.65 | 0.72 | 0.37 | 0.44 | 0.50 | 0.57 |
| | | PI | 0.70 | 0.70 | 0.70 | 0.70 | 0.71 | 0.71 | 0.71 | 0.71 | 0.71 | 0.71 | 0.71 | 0.71 | 0.71 | 0.71 | 0.71 | 0.71 |
| | 40 | TC | 2.13 | 2.13 | 2.14 | 2.17 | 2.26 | 2.26 | 2.26 | 2.26 | 2.34 | 2.34 | 2.36 | 2.34 | 2.51 | 2.51 | 2.51 | 2.51 |
| | | S/T | 0.72 | 0.80 | 0.88 | 0.96 | 0.58 | 0.66 | 0.73 | 0.81 | 0.51 | 0.59 | 0.67 | 0.74 | 0.37 | 0.44 | 0.51 | 0.58 |
| | | PI | 0.77 | 0.77 | 0.77 | 0.77 | 0.78 | 0.78 | 0.78 | 0.78 | 0.78 | 0.78 | 0.78 | 0.78 | 0.78 | 0.78 | 0.78 | 0.78 |
| | 46 | TC | 1.97 | 1.97 | 2.00 | 2.03 | 2.08 | 2.08 | 2.08 | 2.08 | 2.17 | 2.17 | 2.17 | 2.17 | 2.34 | 2.34 | 2.34 | 2.34 |
| | | S/T | 0.72 | 0.81 | 0.89 | 0.97 | 0.58 | 0.66 | 0.75 | 0.83 | 0.51 | 0.59 | 0.67 | 0.75 | 0.36 | 0.44 | 0.51 | 0.58 |
| | | PI | 0.86 | 0.86 | 0.86 | 0.86 | 0.86 | 0.86 | 0.86 | 0.86 | 0.86 | 0.86 | 0.86 | 0.86 | 0.86 | 0.87 | 0.87 | 0.87 |
| | 50 | TC | 1.86 | 1.86 | 1.88 | 1.91 | 1.97 | 1.97 | 1.97 | 1.97 | 2.03 | 2.03 | 2.03 | 2.03 | 2.20 | 2.20 | 2.20 | 2.20 |
| | | S/T | 0.74 | 0.83 | 0.92 | 1.00 | 0.59 | 0.67 | 0.76 | 0.85 | 0.52 | 0.60 | 0.69 | 0.77 | 0.36 | 0.44 | 0.51 | 0.59 |
| | | PI | 0.93 | 0.93 | 0.93 | 0.93 | 0.93 | 0.93 | 0.93 | 0.93 | 0.94 | 0.94 | 0.94 | 0.94 | 0.94 | 0.94 | 0.94 | 0.94 |

| | | | | | | | | | | | | | | | | | | |
|-----|-----|------|------|------|------|------|------|------|------|------|------|------|------|------|------|------|------|------|
| 330 | -15 | TC | 2.83 | 2.83 | 2.83 | 2.86 | 2.95 | 2.95 | 2.95 | 2.95 | 3.03 | 3.03 | 3.03 | 3.03 | 3.23 | 3.23 | 3.23 | 3.23 |
| | | S/T | 0.69 | 0.76 | 0.98 | 1.00 | 0.56 | 0.63 | 0.70 | 0.78 | 0.49 | 0.57 | 0.64 | 0.71 | 0.36 | 0.42 | 0.49 | 0.56 |
| | | PI | 0.50 | 0.50 | 0.50 | 0.50 | 0.50 | 0.50 | 0.50 | 0.50 | 0.50 | 0.50 | 0.50 | 0.50 | 0.50 | 0.50 | 0.50 | 0.50 |
| | -10 | TC | 2.81 | 2.81 | 2.81 | 2.84 | 2.94 | 2.94 | 2.94 | 2.94 | 3.01 | 3.01 | 3.01 | 3.01 | 3.22 | 3.22 | 3.22 | 3.22 |
| | | S/T | 0.69 | 0.77 | 0.99 | 1.00 | 0.56 | 0.63 | 0.71 | 0.79 | 0.49 | 0.57 | 0.64 | 0.72 | 0.36 | 0.43 | 0.49 | 0.56 |
| | | PI | 0.49 | 0.49 | 0.49 | 0.49 | 0.49 | 0.49 | 0.49 | 0.49 | 0.50 | 0.50 | 0.50 | 0.50 | 0.50 | 0.50 | 0.50 | 0.50 |
| | -5 | TC | 2.79 | 2.79 | 2.79 | 2.82 | 2.92 | 2.92 | 2.92 | 2.92 | 3.00 | 3.00 | 3.00 | 3.00 | 3.21 | 3.21 | 3.21 | 3.21 |
| | | S/T | 0.69 | 0.77 | 0.99 | 1.00 | 0.57 | 0.63 | 0.71 | 0.79 | 0.50 | 0.58 | 0.64 | 0.72 | 0.36 | 0.43 | 0.50 | 0.57 |
| | | PI | 0.49 | 0.49 | 0.49 | 0.49 | 0.49 | 0.49 | 0.49 | 0.49 | 0.50 | 0.50 | 0.50 | 0.50 | 0.50 | 0.50 | 0.50 | 0.50 |
| | 0 | TC | 2.78 | 2.78 | 2.78 | 2.81 | 2.91 | 2.91 | 2.91 | 2.91 | 2.99 | 2.99 | 2.99 | 2.99 | 3.21 | 3.21 | 3.21 | 3.21 |
| | | S/T | 0.70 | 0.77 | 1.00 | 1.00 | 0.57 | 0.64 | 0.72 | 0.79 | 0.50 | 0.58 | 0.65 | 0.73 | 0.36 | 0.43 | 0.50 | 0.57 |
| | | PI | 0.49 | 0.49 | 0.49 | 0.49 | 0.50 | 0.50 | 0.50 | 0.50 | 0.50 | 0.50 | 0.50 | 0.50 | 0.50 | 0.50 | 0.50 | 0.50 |
| | 5 | TC | 2.76 | 2.76 | 2.76 | 2.79 | 2.90 | 2.90 | 2.90 | 2.90 | 2.98 | 2.98 | 2.98 | 2.98 | 3.20 | 3.20 | 3.20 | 3.20 |
| | | S/T | 0.70 | 0.78 | 1.00 | 1.00 | 0.57 | 0.64 | 0.72 | 0.80 | 0.50 | 0.58 | 0.65 | 0.73 | 0.36 | 0.43 | 0.50 | 0.57 |
| | | PI | 0.50 | 0.50 | 0.50 | 0.50 | 0.50 | 0.50 | 0.50 | 0.50 | 0.50 | 0.50 | 0.50 | 0.50 | 0.50 | 0.50 | 0.50 | 0.50 |
| | 10 | TC | 2.75 | 2.75 | 2.75 | 2.78 | 2.89 | 2.89 | 2.89 | 2.89 | 2.97 | 2.97 | 2.97 | 2.97 | 3.19 | 3.19 | 3.19 | 3.19 |
| | | S/T | 0.70 | 0.78 | 1.00 | 1.00 | 0.57 | 0.64 | 0.72 | 0.80 | 0.50 | 0.58 | 0.65 | 0.73 | 0.37 | 0.44 | 0.50 | 0.57 |
| | | PI | 0.51 | 0.51 | 0.51 | 0.51 | 0.51 | 0.51 | 0.51 | 0.51 | 0.51 | 0.51 | 0.51 | 0.51 | 0.51 | 0.51 | 0.51 | 0.51 |
| | 15 | TC | 2.73 | 2.73 | 2.73 | 2.75 | 2.87 | 2.87 | 2.87 | 2.87 | 2.95 | 2.95 | 2.95 | 2.95 | 3.18 | 3.18 | 3.18 | 3.18 |
| | | S/T | 0.71 | 0.79 | 0.87 | 0.95 | 0.58 | 0.65 | 0.73 | 0.81 | 0.51 | 0.59 | 0.66 | 0.74 | 0.37 | 0.44 | 0.51 | 0.58 |
| | | PI | 0.52 | 0.52 | 0.52 | 0.52 | 0.52 | 0.52 | 0.52 | 0.52 | 0.52 | 0.52 | 0.52 | 0.52 | 0.52 | 0.52 | 0.52 | 0.52 |
| | 20 | TC | 2.70 | 2.70 | 2.70 | 2.72 | 2.84 | 2.84 | 2.84 | 2.84 | 2.92 | 2.92 | 2.92 | 2.92 | 3.15 | 3.15 | 3.15 | 3.15 |
| | | S/T | 0.71 | 0.79 | 0.87 | 0.95 | 0.58 | 0.65 | 0.73 | 0.81 | 0.51 | 0.59 | 0.66 | 0.74 | 0.37 | 0.44 | 0.51 | 0.58 |
| | | PI | 0.54 | 0.54 | 0.54 | 0.54 | 0.54 | 0.54 | 0.54 | 0.54 | 0.54 | 0.54 | 0.54 | 0.54 | 0.54 | 0.54 | 0.54 | 0.54 |
| 25 | TC | 2.55 | 2.55 | 2.58 | 2.61 | 2.72 | 2.72 | 2.72 | 2.72 | 2.81 | 2.81 | 2.81 | 2.81 | 3.01 | 3.01 | 3.01 | 3.01 | |
| | S/T | 0.72 | 0.81 | 0.89 | 0.97 | 0.58 | 0.66 | 0.74 | 0.82 | 0.51 | 0.59 | 0.67 | 0.75 | 0.36 | 0.44 | 0.51 | 0.58 | |
| | PI | 0.60 | 0.60 | 0.60 | 0.60 | 0.60 | 0.60 | 0.60 | 0.60 | 0.60 | 0.60 | 0.60 | 0.60 | 0.60 | 0.60 | 0.60 | 0.60 | |
| 30 | TC | 2.44 | 2.44 | 2.47 | 2.49 | 2.58 | 2.58 | 2.58 | 2.58 | 2.67 | 2.67 | 2.67 | 2.67 | 2.87 | 2.87 | 2.87 | 2.87 | |
| | S/T | 0.73 | 0.82 | 0.91 | 0.99 | 0.58 | 0.67 | 0.75 | 0.84 | 0.52 | 0.60 | 0.68 | 0.76 | 0.36 | 0.44 | 0.51 | 0.59 | |
| | PI | 0.65 | 0.65 | 0.65 | 0.65 | 0.65 | 0.65 | 0.65 | 0.65 | 0.65 | 0.65 | 0.65 | 0.65 | 0.65 | 0.65 | 0.65 | 0.65 | |
| 35 | TC | 2.32 | 2.32 | 2.35 | 2.38 | 2.47 | 2.47 | 2.47 | 2.47 | 2.55 | 2.55 | 2.55 | 2.55 | 2.75 | 2.75 | 2.75 | 2.75 | |
| | S/T | 0.74 | 0.83 | 0.92 | 1.00 | 0.59 | 0.68 | 0.77 | 0.86 | 0.52 | 0.60 | 0.69 | 0.78 | 0.36 | 0.44 | 0.52 | 0.60 | |
| | PI | 0.71 | 0.71 | 0.71 | 0.71 | 0.71 | 0.71 | 0.71 | 0.71 | 0.71 | 0.71 | 0.71 | 0.71 | 0.71 | 0.71 | 0.71 | 0.71 | |
| 40 | TC | 2.17 | 2.17 | 2.20 | 2.23 | 2.31 | 2.31 | 2.31 | 2.31 | 2.40 | 2.40 | 2.40 | 2.40 | 2.59 | 2.59 | 2.59 | 2.59 | |
| | S/T | 0.76 | 0.87 | 0.97 | 1.00 | 0.60 | 0.70 | 0.80 | 0.89 | 0.52 | 0.62 | 0.71 | 0.81 | 0.35 | 0.44 | 0.53 | 0.61 | |
| | PI | 0.79 | 0.79 | 0.79 | 0.79 | 0.79 | 0.79 | 0.79 | 0.79 | 0.79 | 0.79 | 0.79 | 0.79 | 0.79 | 0.79 | 0.79 | 0.79 | |
| 46 | TC | 2.00 | 2.00 | 2.03 | 2.06 | 2.14 | 2.14 | 2.14 | 2.14 | 2.17 | 2.23 | 2.23 | 2.23 | 2.40 | 2.40 | 2.40 | 2.40 | |
| | S/T | 0.77 | 0.88 | 0.99 | 1.00 | 0.60 | 0.71 | 0.81 | 0.91 | 0.53 | 0.62 | 0.72 | 0.82 | 0.35 | 0.44 | 0.53 | 0.62 | |
| | PI | 0.87 | 0.87 | 0.87 | 0.87 | 0.88 | 0.88 | 0.88 | 0.88 | 0.88 | 0.88 | 0.88 | 0.88 | 0.88 | 0.89 | 0.89 | 0.89 | |
| 50 | TC | 1.89 | 1.91 | 1.94 | 1.97 | 2.03 | 2.03 | 2.03 | 2.06 | 2.09 | 2.09 | 2.09 | 2.09 | 2.26 | 2.26 | 2.26 | 2.26 | |
| | S/T | 0.79 | 0.90 | 1.00 | 1.00 | 0.61 | 0.72 | 0.83 | 0.93 | 0.53 | 0.64 | 0.74 | 0.85 | 0.34 | 0.44 | 0.54 | 0.91 | |
| | PI | 0.95 | 0.95 | 0.95 | 0.95 | 0.95 | 0.95 | 0.95 | 0.95 | 0.95 | 0.95 | 0.95 | 0.95 | 0.95 | 0.96 | 0.96 | 0.96 | |
| 460 | -15 | TC | 2.89 | 2.92 | 2.95 | 2.98 | 3.01 | 3.01 | 3.01 | 3.04 | 3.09 | 3.09 | 3.09 | 3.09 | 3.29 | 3.29 | 3.29 | 3.29 |
| | | S/T | 0.75 | 0.86 | 1.00 | 1.00 | 0.59 | 0.69 | 0.79 | 0.98 | 0.51 | 0.61 | 0.70 | 0.81 | 0.33 | 0.42 | 0.52 | 0.61 |
| | | PI | 0.50 | 0.50 | 0.50 | 0.50 | 0.50 | 0.50 | 0.50 | 0.50 | 0.51 | 0.51 | 0.51 | 0.51 | 0.51 | 0.51 | 0.51 | 0.51 |
| | -10 | TC | 2.87 | 2.90 | 2.93 | 2.96 | 2.99 | 2.99 | 2.99 | 3.02 | 3.07 | 3.07 | 3.07 | 3.07 | 3.28 | 3.28 | 3.28 | 3.28 |
| | | S/T | 0.76 | 0.86 | 1.00 | 1.00 | 0.59 | 0.69 | 0.80 | 0.98 | 0.51 | 0.61 | 0.71 | 0.82 | 0.33 | 0.43 | 0.52 | 0.61 |
| | | PI | 0.50 | 0.50 | 0.50 | 0.50 | 0.50 | 0.50 | 0.50 | 0.50 | 0.50 | 0.50 | 0.50 | 0.50 | 0.50 | 0.51 | 0.51 | 0.51 |
| | -5 | TC | 2.85 | 2.88 | 2.91 | 2.94 | 2.98 | 2.98 | 2.98 | 3.01 | 3.06 | 3.06 | 3.06 | 3.06 | 3.27 | 3.27 | 3.27 | 3.27 |
| | | S/T | 0.76 | 0.87 | 1.00 | 1.00 | 0.59 | 0.69 | 0.80 | 0.99 | 0.52 | 0.61 | 0.71 | 0.82 | 0.33 | 0.43 | 0.53 | 0.61 |
| | | PI | 0.50 | 0.50 | 0.50 | 0.50 | 0.50 | 0.50 | 0.50 | 0.50 | 0.50 | 0.50 | 0.50 | 0.50 | 0.51 | 0.51 | 0.51 | 0.51 |
| | 0 | TC | 2.84 | 2.87 | 2.90 | 2.93 | 2.97 | 2.97 | 2.97 | 3.00 | 3.05 | 3.05 | 3.05 | 3.05 | 3.26 | 3.26 | 3.26 | 3.26 |
| | | S/T | 0.76 | 0.87 | 1.00 | 1.00 | 0.60 | 0.70 | 0.80 | 0.99 | 0.52 | 0.62 | 0.72 | 0.82 | 0.33 | 0.43 | 0.53 | 0.62 |
| | | PI | 0.50 | 0.50 | 0.50 | 0.50 | 0.50 | 0.50 | 0.50 | 0.50 | 0.51 | 0.51 | 0.51 | 0.51 | 0.51 | 0.51 | 0.51 | 0.51 |
| | 5 | TC | 2.82 | 2.85 | 2.88 | 2.91 | 2.96 | 2.96 | 2.96 | 2.99 | 3.04 | 3.04 | 3.04 | 3.04 | 3.26 | 3.26 | 3.26 | 3.26 |
| | | S/T | 0.77 | 0.88 | 1.00 | 1.00 | 0.60 | 0.70 | 0.81 | 1.00 | 0.52 | 0.62 | 0.72 | 0.83 | 0.33 | 0.43 | 0.53 | 0.62 |
| | | PI | 0.51 | 0.51 | 0.51 | 0.51 | 0.51 | 0.51 | 0.51 | 0.51 | 0.51 | 0.51 | 0.51 | 0.51 | 0.51 | 0.51 | 0.51 | 0.51 |
| | 10 | TC | 2.81 | 2.84 | 2.87 | 2.89 | 2.95 | 2.95 | 2.95 | 2.98 | 3.03 | 3.03 | 3.03 | 3.03 | 3.25 | 3.25 | 3.25 | 3.25 |
| | | S/T | 0.77 | 0.88 | 1.00 | 1.00 | 0.60 | 0.70 | 0.81 | 1.00 | 0.52 | 0.62 | 0.72 | 0.83 | 0.34 | 0.44 | 0.53 | 0.62 |
| | | PI | 0.52 | 0.52 | 0.52 | 0.52 | 0.52 | 0.52 | 0.52 | 0.52 | 0.52 | 0.52 | 0.52 | 0.52 | 0.52 | 0.52 | 0.52 | 0.52 |
| | 15 | TC | 2.78 | 2.81 | 2.84 | 2.87 | 2.93 | 2.93 | 2.93 | 2.96 | 3.01 | 3.01 | 3.01 | 3.01 | 3.24 | 3.24 | 3.24 | 3.24 |
| | | S/T | 0.78 | 0.89 | 0.99 | 1.00 | 0.61 | 0.71 | 0.82 | 0.92 | 0.53 | 0.63 | 0.73 | 0.84 | 0.34 | 0.44 | 0.54 | 0.63 |
| | | PI | 0.53 | 0.53 | 0.53 | 0.53 | 0.53 | 0.53 | 0.53 | 0.53 | 0.53 | 0.53 | 0.53 | 0.53 | 0.53 | 0.53 | 0.53 | 0.53 |
| | 20 | TC | 2.75 | 2.78 | 2.81 | 2.84 | 2.90 | 2.90 | 2.90 | 2.92 | 2.98 | 2.98 | 2.98 | 2.98 | 3.21 | 3.21 | 3.21 | 3.21 |
| | | S/T | 0.78 | 0.89 | 0.99 | 1.00 | 0.61 | 0.71 | 0.82 | 0.92 | 0.53 | 0.63 | 0.73 | 0.84 | 0.34 | 0.44 | 0.54 | 0.63 |
| | | PI | 0.55 | 0.55 | 0.55 | 0.55 | 0.55 | 0.55 | 0.55 | 0.55 | 0.55 | 0.55 | 0.55 | 0.55 | 0.55 | 0.55 | 0.55 | 0.55 |
| 25 | TC | 2.61 | 2.64 | 2.67 | 2.70 | 2.78 | 2.78 | 2.78 | 2.81 | 2.87 | 2.87 | 2.87 | 2.87 | 3.07 | 3.07 | 3.07 | 3.07 | |
| | S/T | 0.79 | 0.91 | 1.00 | 1.00 | 0.61 | 0.73 | 0.84 | 0.94 | 0.53 | 0.64 | 0.75 | 0.85 | 0.34 | 0.44 | 0.54 | 0.64 | |
| | PI | 0.61 | 0.61 | 0.61 | 0.61 | 0.61 | 0.61 | 0.61 | 0.61 | 0.61 | 0.61 | 0.61 | 0.61 | 0.61 | 0.61 | 0.61 | 0.61 | |
| 30 | TC | 2.49 | 2.52 | 2.55 | 2.58 | 2.64 | 2.64 | 2.64 | 2.67 | 2.72 | 2.72 | 2.72 | 2.72 | 2.95 | 2.95 | 2.95 | 2.95 | |
| | S/T | 0.81 | 0.93 | 1.00 | 1.00 | 0.62 | 0.74 | 0.86 | 0.97 | 0.54 | 0.65 | 0.76 | 0.88 | 0.34 | 0.44 | 0.55 | 0.65 | |
| | PI | 0.66 | 0.66 | 0.66 | 0.66 | 0.66 | 0.66 | 0.66 | 0.66 | 0.66 | 0.66 | 0.66 | 0.66 | 0.66 | 0.67 | 0.67 | 0.67 | |
| 35 | TC | 2.38 | 2.41 | 2.44 | 2.47 | 2.52 | 2.52 | 2.52 | 2.55 | 2.61 | 2.61 | 2.64 | 2.67 | 2.81 | 2.81 | 2.81 | 2.81 | |
| | S/T | 0.82 | 0.95 | 1.00 | 1.00 | 0.63 | 0.75 | 0.88 | 0.99 | 0.54 | 0.66 | 0.77 | 0.89 | 0.34 | 0.45 | 0.55 | 0.66 | |
| | PI | 0.72 | 0.72 | 0.72 | 0.72 | 0.73 | 0.73 | 0.73 | 0.73 | 0.73 | 0.73 | 0.73 | 0.73 | 0.73 | 0.73 | 0.73 | 0.73 | |
| 40 | TC | 2.23 | 2.26 | 2.29 | 2.31 | 2.37 | 2.37 | 2.38 | 2.41 | 2.44 | 2.44 | 2.46 | 2.49 | 2.64 | 2.64 | 2.64 | 2.64 | |
| | S/T | 0.86 | 1.00 | 1.00 | 1.00 | 0.65 | 0.78 | 0.91 | 1.00 | 0.55 | 0.68 | 0.81 | 0.93 | 0.33 | 0.45 | 0.57 | 0.90 | |
| | PI | 0.80 | 0.80 | 0.80 | 0.80 | 0.81 | 0.81 | | | | | | | | | | | |

| 42QH009D8SH+38QH009D8SH | | | | | | | | | | | | | | | | | | | |
|-------------------------|---------------|-----------|-----------|------|------|------|------|------|------|------|------|------|------|------|------|------|------|------|------|
| INDOOR AIRFLOW (CMH) | OUTDOOR DB(C) | ID WB (C) | 16.0 | | | | 18.0 | | | | 19.0 | | | | 22.0 | | | | |
| | | | ID DB (C) | 23.0 | 25.0 | 27.0 | 30.0 | 23.0 | 25.0 | 27.0 | 30.0 | 23.0 | 25.0 | 27.0 | 30.0 | 23.0 | 25.0 | 27.0 | 30.0 |
| 300 | -15 | TC | 2.75 | 2.73 | 2.73 | 2.76 | 2.89 | 2.95 | 2.95 | 2.95 | 2.97 | 2.97 | 2.97 | 2.97 | 3.14 | 3.14 | 3.14 | 3.14 | |
| | | S/T | 0.68 | 0.75 | 0.83 | 0.90 | 0.55 | 0.62 | 0.70 | 0.76 | 0.49 | 0.56 | 0.63 | 0.70 | 0.36 | 0.42 | 0.48 | 0.55 | |
| | | PI | 0.44 | 0.45 | 0.45 | 0.44 | 0.45 | 0.45 | 0.45 | 0.45 | 0.45 | 0.45 | 0.45 | 0.45 | 0.45 | 0.44 | 0.44 | 0.44 | 0.44 |
| | -10 | TC | 2.73 | 2.72 | 2.72 | 2.75 | 2.87 | 2.94 | 2.94 | 2.94 | 2.95 | 2.95 | 2.95 | 2.95 | 3.13 | 3.13 | 3.13 | 3.13 | |
| | | S/T | 0.68 | 0.76 | 0.83 | 0.90 | 0.55 | 0.62 | 0.70 | 0.77 | 0.49 | 0.56 | 0.63 | 0.70 | 0.36 | 0.43 | 0.49 | 0.55 | |
| | | PI | 0.44 | 0.44 | 0.44 | 0.44 | 0.44 | 0.44 | 0.44 | 0.44 | 0.45 | 0.45 | 0.45 | 0.45 | 0.44 | 0.44 | 0.44 | 0.44 | |
| | -5 | TC | 2.71 | 2.70 | 2.70 | 2.73 | 2.86 | 2.92 | 2.92 | 2.92 | 2.94 | 2.94 | 2.94 | 2.94 | 3.12 | 3.12 | 3.12 | 3.12 | |
| | | S/T | 0.68 | 0.76 | 0.84 | 0.91 | 0.56 | 0.63 | 0.70 | 0.77 | 0.50 | 0.57 | 0.63 | 0.70 | 0.36 | 0.43 | 0.49 | 0.56 | |
| | | PI | 0.44 | 0.44 | 0.44 | 0.44 | 0.44 | 0.44 | 0.44 | 0.44 | 0.45 | 0.45 | 0.45 | 0.45 | 0.44 | 0.44 | 0.44 | 0.44 | |
| | 0 | TC | 2.70 | 2.69 | 2.69 | 2.72 | 2.85 | 2.91 | 2.91 | 2.91 | 2.93 | 2.93 | 2.93 | 2.93 | 3.12 | 3.12 | 3.12 | 3.12 | |
| | | S/T | 0.69 | 0.76 | 0.84 | 0.91 | 0.56 | 0.63 | 0.71 | 0.77 | 0.50 | 0.57 | 0.64 | 0.71 | 0.36 | 0.43 | 0.49 | 0.56 | |
| | | PI | 0.44 | 0.44 | 0.44 | 0.44 | 0.45 | 0.45 | 0.45 | 0.45 | 0.45 | 0.45 | 0.45 | 0.45 | 0.44 | 0.44 | 0.44 | 0.44 | |
| | 5 | TC | 2.69 | 2.68 | 2.68 | 2.70 | 2.84 | 2.90 | 2.90 | 2.90 | 2.92 | 2.92 | 2.92 | 2.92 | 3.11 | 3.11 | 3.11 | 3.11 | |
| | | S/T | 0.69 | 0.77 | 0.85 | 0.92 | 0.56 | 0.63 | 0.71 | 0.78 | 0.50 | 0.57 | 0.64 | 0.71 | 0.36 | 0.43 | 0.49 | 0.56 | |
| | | PI | 0.45 | 0.45 | 0.45 | 0.45 | 0.45 | 0.45 | 0.45 | 0.45 | 0.45 | 0.45 | 0.45 | 0.45 | 0.44 | 0.44 | 0.44 | 0.44 | |
| | 10 | TC | 2.67 | 2.66 | 2.66 | 2.69 | 2.83 | 2.89 | 2.89 | 2.89 | 2.91 | 2.91 | 2.91 | 2.91 | 3.11 | 3.11 | 3.11 | 3.11 | |
| | | S/T | 0.69 | 0.77 | 0.85 | 0.92 | 0.56 | 0.64 | 0.71 | 0.78 | 0.50 | 0.57 | 0.64 | 0.71 | 0.37 | 0.44 | 0.50 | 0.56 | |
| | | PI | 0.46 | 0.46 | 0.46 | 0.46 | 0.46 | 0.46 | 0.46 | 0.46 | 0.46 | 0.46 | 0.46 | 0.46 | 0.45 | 0.45 | 0.45 | 0.45 | |
| | 15 | TC | 2.65 | 2.64 | 2.64 | 2.67 | 2.81 | 2.87 | 2.87 | 2.87 | 2.89 | 2.89 | 2.89 | 2.89 | 3.09 | 3.09 | 3.09 | 3.09 | |
| | | S/T | 0.70 | 0.78 | 0.86 | 0.93 | 0.57 | 0.64 | 0.72 | 0.79 | 0.51 | 0.58 | 0.65 | 0.72 | 0.37 | 0.44 | 0.50 | 0.57 | |
| | | PI | 0.47 | 0.47 | 0.47 | 0.47 | 0.47 | 0.47 | 0.47 | 0.47 | 0.47 | 0.47 | 0.47 | 0.47 | 0.46 | 0.46 | 0.46 | 0.46 | |
| | 20 | TC | 2.62 | 2.61 | 2.61 | 2.64 | 2.78 | 2.78 | 2.78 | 2.78 | 2.87 | 2.87 | 2.87 | 2.87 | 3.07 | 3.07 | 3.07 | 3.07 | |
| | | S/T | 0.70 | 0.78 | 0.86 | 0.93 | 0.57 | 0.64 | 0.72 | 0.79 | 0.51 | 0.58 | 0.65 | 0.72 | 0.37 | 0.44 | 0.50 | 0.57 | |
| | | PI | 0.48 | 0.48 | 0.48 | 0.48 | 0.48 | 0.48 | 0.48 | 0.48 | 0.48 | 0.48 | 0.48 | 0.48 | 0.47 | 0.47 | 0.47 | 0.47 | |
| | 25 | TC | 2.49 | 2.49 | 2.49 | 2.52 | 2.67 | 2.67 | 2.67 | 2.67 | 2.72 | 2.72 | 2.72 | 2.72 | 2.95 | 2.95 | 2.95 | 2.95 | |
| | | S/T | 0.71 | 0.79 | 0.87 | 0.95 | 0.57 | 0.65 | 0.72 | 0.80 | 0.51 | 0.59 | 0.66 | 0.73 | 0.37 | 0.44 | 0.50 | 0.57 | |
| | | PI | 0.53 | 0.53 | 0.53 | 0.53 | 0.53 | 0.53 | 0.53 | 0.53 | 0.53 | 0.53 | 0.53 | 0.53 | 0.53 | 0.53 | 0.53 | 0.53 | |
| | 30 | TC | 2.38 | 2.38 | 2.38 | 2.41 | 2.52 | 2.52 | 2.52 | 2.52 | 2.61 | 2.61 | 2.61 | 2.61 | 2.81 | 2.81 | 2.81 | 2.81 | |
| | | S/T | 0.72 | 0.80 | 0.88 | 0.96 | 0.58 | 0.66 | 0.74 | 0.82 | 0.51 | 0.59 | 0.67 | 0.74 | 0.37 | 0.44 | 0.51 | 0.58 | |
| | | PI | 0.58 | 0.58 | 0.58 | 0.58 | 0.58 | 0.58 | 0.58 | 0.58 | 0.58 | 0.58 | 0.58 | 0.58 | 0.58 | 0.58 | 0.58 | 0.58 | |
| | 35 | TC | 2.26 | 2.26 | 2.29 | 2.32 | 2.41 | 2.41 | 2.41 | 2.41 | 2.49 | 2.49 | 2.52 | 2.49 | 2.67 | 2.67 | 2.67 | 2.67 | |
| | | S/T | 0.72 | 0.81 | 0.90 | 0.98 | 0.58 | 0.66 | 0.75 | 0.83 | 0.51 | 0.59 | 0.67 | 0.76 | 0.36 | 0.44 | 0.51 | 0.59 | |
| | | PI | 0.64 | 0.64 | 0.64 | 0.64 | 0.64 | 0.64 | 0.64 | 0.64 | 0.64 | 0.64 | 0.64 | 0.64 | 0.64 | 0.64 | 0.64 | 0.64 | |
| | 40 | TC | 2.13 | 2.13 | 2.15 | 2.18 | 2.26 | 2.26 | 2.26 | 2.26 | 2.34 | 2.34 | 2.36 | 2.34 | 2.51 | 2.51 | 2.51 | 2.51 | |
| | | S/T | 0.74 | 0.84 | 0.93 | 1.00 | 0.59 | 0.68 | 0.77 | 0.86 | 0.52 | 0.61 | 0.70 | 0.78 | 0.35 | 0.44 | 0.52 | 0.60 | |
| | | PI | 0.70 | 0.70 | 0.70 | 0.70 | 0.71 | 0.71 | 0.71 | 0.71 | 0.71 | 0.71 | 0.71 | 0.71 | 0.71 | 0.71 | 0.71 | 0.71 | |
| | 46 | TC | 1.97 | 1.97 | 2.00 | 2.03 | 2.08 | 2.08 | 2.08 | 2.08 | 2.17 | 2.17 | 2.17 | 2.17 | 2.34 | 2.34 | 2.34 | 2.34 | |
| | | S/T | 0.75 | 0.86 | 0.95 | 1.00 | 0.60 | 0.69 | 0.79 | 0.88 | 0.52 | 0.61 | 0.70 | 0.80 | 0.35 | 0.44 | 0.52 | 0.61 | |
| | | PI | 0.78 | 0.78 | 0.78 | 0.78 | 0.79 | 0.79 | 0.79 | 0.79 | 0.79 | 0.79 | 0.79 | 0.79 | 0.79 | 0.79 | 0.79 | 0.79 | |
| | 50 | TC | 1.86 | 1.86 | 1.88 | 1.91 | 1.97 | 1.97 | 1.97 | 2.00 | 2.03 | 2.03 | 2.03 | 2.03 | 2.20 | 2.20 | 2.20 | 2.20 | |
| | | S/T | 0.77 | 0.88 | 0.98 | 1.00 | 0.60 | 0.70 | 0.81 | 0.90 | 0.53 | 0.62 | 0.72 | 0.82 | 0.35 | 0.44 | 0.53 | 0.62 | |
| | | PI | 0.85 | 0.85 | 0.85 | 0.85 | 0.85 | 0.85 | 0.85 | 0.85 | 0.85 | 0.85 | 0.85 | 0.85 | 0.86 | 0.86 | 0.86 | 0.86 | |
| | 360 | -15 | TC | 2.83 | 2.83 | 2.86 | 2.89 | 2.95 | 2.95 | 2.95 | 3.03 | 3.03 | 3.03 | 3.03 | 3.23 | 3.23 | 3.23 | 3.23 | |
| | | | S/T | 0.70 | 0.79 | 0.98 | 1.00 | 0.56 | 0.65 | 0.72 | 0.81 | 0.50 | 0.58 | 0.66 | 0.73 | 0.35 | 0.42 | 0.49 | 0.57 |
| | | | PI | 0.45 | 0.45 | 0.45 | 0.45 | 0.44 | 0.44 | 0.44 | 0.44 | 0.45 | 0.45 | 0.45 | 0.45 | 0.45 | 0.45 | 0.45 | 0.45 |
| | | -10 | TC | 2.81 | 2.81 | 2.84 | 2.87 | 2.94 | 2.94 | 2.94 | 2.94 | 3.01 | 3.01 | 3.01 | 3.01 | 3.22 | 3.22 | 3.22 | 3.22 |
| | | | S/T | 0.71 | 0.80 | 0.99 | 1.00 | 0.56 | 0.65 | 0.73 | 0.82 | 0.50 | 0.58 | 0.66 | 0.74 | 0.35 | 0.43 | 0.49 | 0.57 |
| | | | PI | 0.45 | 0.45 | 0.45 | 0.45 | 0.44 | 0.44 | 0.44 | 0.44 | 0.44 | 0.44 | 0.44 | 0.44 | 0.45 | 0.45 | 0.45 | 0.45 |
| -5 | | TC | 2.79 | 2.79 | 2.82 | 2.85 | 2.92 | 2.92 | 2.92 | 2.92 | 3.00 | 3.00 | 3.00 | 3.00 | 3.21 | 3.21 | 3.21 | 3.21 | |
| | | S/T | 0.71 | 0.80 | 0.99 | 1.00 | 0.57 | 0.65 | 0.73 | 0.82 | 0.51 | 0.59 | 0.66 | 0.74 | 0.35 | 0.43 | 0.50 | 0.58 | |
| | | PI | 0.45 | 0.45 | 0.45 | 0.45 | 0.44 | 0.44 | 0.44 | 0.44 | 0.44 | 0.44 | 0.44 | 0.44 | 0.45 | 0.45 | 0.45 | 0.45 | |
| 0 | | TC | 2.78 | 2.78 | 2.81 | 2.84 | 2.91 | 2.91 | 2.91 | 2.91 | 2.99 | 2.99 | 2.99 | 2.99 | 3.21 | 3.21 | 3.21 | 3.21 | |
| | | S/T | 0.72 | 0.80 | 1.00 | 1.00 | 0.57 | 0.66 | 0.74 | 0.82 | 0.51 | 0.59 | 0.67 | 0.74 | 0.35 | 0.43 | 0.50 | 0.58 | |
| | | PI | 0.45 | 0.45 | 0.45 | 0.45 | 0.44 | 0.44 | 0.44 | 0.44 | 0.45 | 0.45 | 0.45 | 0.45 | 0.45 | 0.45 | 0.45 | 0.45 | |
| 5 | | TC | 2.76 | 2.76 | 2.79 | 2.82 | 2.90 | 2.90 | 2.90 | 2.90 | 2.98 | 2.98 | 2.98 | 2.98 | 3.20 | 3.20 | 3.20 | 3.20 | |
| | | S/T | 0.72 | 0.81 | 1.00 | 1.00 | 0.57 | 0.66 | 0.74 | 0.83 | 0.51 | 0.59 | 0.67 | 0.75 | 0.35 | 0.43 | 0.50 | 0.58 | |
| | | PI | 0.46 | 0.46 | 0.46 | 0.46 | 0.45 | 0.45 | 0.45 | 0.45 | 0.45 | 0.45 | 0.45 | 0.45 | 0.45 | 0.45 | 0.45 | 0.45 | |
| 10 | | TC | 2.75 | 2.75 | 2.78 | 2.81 | 2.89 | 2.89 | 2.89 | 2.89 | 2.97 | 2.97 | 2.97 | 2.97 | 3.19 | 3.19 | 3.19 | 3.19 | |
| | | S/T | 0.72 | 0.81 | 1.00 | 1.00 | 0.57 | 0.66 | 0.74 | 0.83 | 0.51 | 0.59 | 0.67 | 0.75 | 0.36 | 0.44 | 0.50 | 0.58 | |
| | | PI | 0.46 | 0.46 | 0.46 | 0.46 | 0.46 | 0.46 | 0.46 | 0.46 | 0.46 | 0.46 | 0.46 | 0.46 | 0.46 | 0.46 | 0.46 | 0.46 | |
| 15 | | TC | 2.73 | 2.73 | 2.75 | 2.78 | 2.87 | 2.87 | 2.87 | 2.87 | 2.95 | 2.95 | 2.95 | 2.95 | 3.18 | 3.18 | 3.18 | 3.18 | |
| | | S/T | 0.73 | 0.82 | 0.90 | 0.99 | 0.58 | 0.67 | 0.75 | 0.84 | 0.52 | 0.60 | 0.68 | 0.76 | 0.36 | 0.44 | 0.51 | 0.59 | |
| | | PI | 0.48 | 0.48 | 0.48 | 0.48 | 0.47 | 0.47 | 0.47 | 0.47 | 0.47 | 0.47 | 0.47 | 0.47 | 0.47 | 0.47 | 0.47 | 0.47 | |
| 20 | | TC | 2.70 | 2.70 | 2.72 | 2.75 | 2.84 | 2.84 | 2.84 | 2.84 | 2.92 | 2.92 | 2.92 | 2.92 | 3.15 | 3.15 | 3.15 | 3.15 | |
| | | S/T | 0.73 | 0.82 | 0.90 | 0.99 | 0.58 | 0.67 | 0.75 | 0.84 | 0.52 | 0.60 | 0.68 | 0.76 | 0.36 | 0.44 | 0.51 | 0.59 | |
| | | PI | 0.49 | 0.49 | 0.49 | 0.49 | 0.48 | 0.48 | 0.48 | 0.48 | 0.48 | 0.48 | 0.48 | 0.48 | 0.48 | 0.48 | 0.48 | 0.48 | |
| 25 | | TC | 2.55 | 2.55 | 2.58 | 2.61 | 2.72 | 2.72 | 2.72 | 2.72 | 2.81 | 2.81 | 2.81 | 2.81 | 3.01 | 3.01 | 3.01 | 3.01 | |
| | | S/T | 0.74 | 0.83 | 0.92 | 1.00 | 0.59 | 0.68 | 0.76 | 0.85 | | | | | | | | | |

| | | | | | | | | | | | | | | | | | | |
|-----|-----|------|------|------|------|------|------|------|------|------|------|------|------|------|------|------|------|------|
| 510 | -15 | TC | 2.89 | 2.92 | 2.95 | 2.98 | 3.01 | 3.01 | 3.01 | 3.04 | 3.09 | 3.09 | 3.09 | 3.09 | 3.29 | 3.29 | 3.29 | 3.29 |
| | | S/T | 0.78 | 0.90 | 1.00 | 1.00 | 0.60 | 0.71 | 0.83 | 0.98 | 0.52 | 0.63 | 0.74 | 0.85 | 0.33 | 0.42 | 0.53 | 0.64 |
| | | PI | 0.45 | 0.45 | 0.45 | 0.45 | 0.45 | 0.45 | 0.45 | 0.45 | 0.45 | 0.45 | 0.45 | 0.45 | 0.45 | 0.46 | 0.46 | 0.46 |
| | -10 | TC | 2.87 | 2.90 | 2.93 | 2.96 | 2.99 | 2.99 | 2.99 | 3.02 | 3.07 | 3.07 | 3.07 | 3.07 | 3.28 | 3.28 | 3.28 | 3.28 |
| | | S/T | 0.79 | 0.90 | 1.00 | 1.00 | 0.60 | 0.72 | 0.83 | 0.98 | 0.52 | 0.63 | 0.75 | 0.85 | 0.33 | 0.43 | 0.53 | 0.64 |
| | | PI | 0.45 | 0.45 | 0.45 | 0.45 | 0.45 | 0.45 | 0.45 | 0.45 | 0.45 | 0.45 | 0.45 | 0.45 | 0.45 | 0.46 | 0.46 | 0.46 |
| | -5 | TC | 2.85 | 2.88 | 2.91 | 2.94 | 2.98 | 2.98 | 2.98 | 3.01 | 3.06 | 3.06 | 3.06 | 3.06 | 3.27 | 3.27 | 3.27 | 3.27 |
| | | S/T | 0.79 | 0.91 | 1.00 | 1.00 | 0.60 | 0.72 | 0.84 | 0.99 | 0.53 | 0.63 | 0.75 | 0.86 | 0.33 | 0.43 | 0.54 | 0.64 |
| | | PI | 0.45 | 0.45 | 0.45 | 0.45 | 0.45 | 0.45 | 0.45 | 0.45 | 0.45 | 0.45 | 0.45 | 0.45 | 0.45 | 0.46 | 0.46 | 0.46 |
| | 0 | TC | 2.84 | 2.87 | 2.90 | 2.93 | 2.97 | 2.97 | 2.97 | 3.00 | 3.05 | 3.05 | 3.05 | 3.05 | 3.26 | 3.26 | 3.26 | 3.26 |
| | | S/T | 0.79 | 0.91 | 1.00 | 1.00 | 0.61 | 0.73 | 0.84 | 0.99 | 0.53 | 0.64 | 0.75 | 0.86 | 0.33 | 0.43 | 0.54 | 0.65 |
| | | PI | 0.45 | 0.45 | 0.45 | 0.45 | 0.45 | 0.45 | 0.45 | 0.45 | 0.45 | 0.45 | 0.45 | 0.45 | 0.46 | 0.46 | 0.46 | 0.46 |
| | 5 | TC | 2.82 | 2.85 | 2.88 | 2.91 | 2.96 | 2.96 | 2.96 | 2.99 | 3.04 | 3.04 | 3.04 | 3.04 | 3.26 | 3.26 | 3.26 | 3.26 |
| | | S/T | 0.80 | 0.92 | 1.00 | 1.00 | 0.61 | 0.73 | 0.85 | 1.00 | 0.53 | 0.64 | 0.76 | 0.87 | 0.33 | 0.43 | 0.54 | 0.65 |
| | | PI | 0.46 | 0.46 | 0.46 | 0.46 | 0.46 | 0.46 | 0.46 | 0.46 | 0.46 | 0.46 | 0.46 | 0.46 | 0.46 | 0.46 | 0.46 | 0.46 |
| | 10 | TC | 2.81 | 2.84 | 2.87 | 2.89 | 2.95 | 2.95 | 2.95 | 2.98 | 3.03 | 3.03 | 3.03 | 3.03 | 3.25 | 3.25 | 3.25 | 3.25 |
| | | S/T | 0.80 | 0.92 | 1.00 | 1.00 | 0.61 | 0.73 | 0.85 | 1.00 | 0.53 | 0.64 | 0.76 | 0.87 | 0.34 | 0.44 | 0.54 | 0.65 |
| | | PI | 0.46 | 0.46 | 0.46 | 0.46 | 0.46 | 0.46 | 0.46 | 0.46 | 0.47 | 0.47 | 0.47 | 0.47 | 0.47 | 0.47 | 0.47 | 0.47 |
| 15 | TC | 2.78 | 2.81 | 2.84 | 2.87 | 2.93 | 2.93 | 2.93 | 2.96 | 3.01 | 3.01 | 3.01 | 3.01 | 3.24 | 3.24 | 3.24 | 3.24 | |
| | S/T | 0.81 | 0.93 | 1.00 | 1.00 | 0.62 | 0.74 | 0.86 | 0.97 | 0.54 | 0.65 | 0.77 | 0.88 | 0.34 | 0.44 | 0.55 | 0.66 | |
| | PI | 0.48 | 0.48 | 0.48 | 0.48 | 0.48 | 0.48 | 0.48 | 0.48 | 0.48 | 0.48 | 0.48 | 0.48 | 0.48 | 0.48 | 0.48 | 0.48 | |
| 20 | TC | 2.75 | 2.78 | 2.81 | 2.84 | 2.90 | 2.90 | 2.90 | 2.92 | 2.98 | 2.98 | 2.98 | 2.98 | 3.21 | 3.21 | 3.21 | 3.21 | |
| | S/T | 0.81 | 0.93 | 1.00 | 1.00 | 0.62 | 0.74 | 0.86 | 0.97 | 0.54 | 0.65 | 0.77 | 0.88 | 0.34 | 0.44 | 0.55 | 0.66 | |
| | PI | 0.49 | 0.49 | 0.49 | 0.49 | 0.49 | 0.49 | 0.49 | 0.49 | 0.49 | 0.49 | 0.49 | 0.49 | 0.49 | 0.49 | 0.49 | 0.49 | |
| 25 | TC | 2.61 | 2.64 | 2.67 | 2.70 | 2.78 | 2.78 | 2.78 | 2.81 | 2.87 | 2.87 | 2.87 | 2.90 | 3.07 | 3.07 | 3.07 | 3.07 | |
| | S/T | 0.83 | 0.95 | 1.00 | 1.00 | 0.63 | 0.75 | 0.88 | 1.00 | 0.54 | 0.66 | 0.78 | 0.89 | 0.33 | 0.45 | 0.56 | 0.67 | |
| | PI | 0.55 | 0.55 | 0.55 | 0.55 | 0.55 | 0.55 | 0.55 | 0.55 | 0.55 | 0.55 | 0.55 | 0.55 | 0.55 | 0.55 | 0.55 | 0.55 | |
| 30 | TC | 2.49 | 2.52 | 2.55 | 2.58 | 2.64 | 2.64 | 2.67 | 2.70 | 2.72 | 2.72 | 2.72 | 2.75 | 2.95 | 2.95 | 2.95 | 2.95 | |
| | S/T | 0.84 | 0.97 | 1.00 | 1.00 | 0.64 | 0.77 | 0.90 | 1.00 | 0.55 | 0.67 | 0.80 | 0.92 | 0.33 | 0.45 | 0.56 | 0.68 | |
| | PI | 0.60 | 0.60 | 0.60 | 0.60 | 0.60 | 0.60 | 0.60 | 0.60 | 0.60 | 0.60 | 0.60 | 0.60 | 0.60 | 0.60 | 0.60 | 0.60 | |
| 35 | TC | 2.38 | 2.41 | 2.44 | 2.47 | 2.52 | 2.52 | 2.55 | 2.58 | 2.61 | 2.61 | 2.64 | 2.67 | 2.81 | 2.81 | 2.81 | 2.81 | |
| | S/T | 0.86 | 1.00 | 1.00 | 1.00 | 0.65 | 0.79 | 0.92 | 1.00 | 0.55 | 0.68 | 0.81 | 0.93 | 0.33 | 0.45 | 0.57 | 0.69 | |
| | PI | 0.66 | 0.66 | 0.66 | 0.66 | 0.66 | 0.66 | 0.66 | 0.66 | 0.66 | 0.66 | 0.66 | 0.66 | 0.66 | 0.66 | 0.66 | 0.66 | |
| 40 | TC | 2.23 | 2.26 | 2.29 | 2.31 | 2.37 | 2.37 | 2.40 | 2.43 | 2.44 | 2.44 | 2.46 | 2.49 | 2.64 | 2.64 | 2.64 | 2.64 | |
| | S/T | 0.90 | 1.00 | 1.00 | 1.00 | 0.67 | 0.82 | 0.96 | 1.00 | 0.56 | 0.71 | 0.85 | 0.99 | 0.32 | 0.46 | 0.59 | 0.90 | |
| | PI | 0.73 | 0.73 | 0.73 | 0.73 | 0.73 | 0.73 | 0.73 | 0.73 | 0.73 | 0.73 | 0.73 | 0.73 | 0.73 | 0.73 | 0.73 | 0.73 | |
| 46 | TC | 2.06 | 2.09 | 2.11 | 2.14 | 2.20 | 2.20 | 2.23 | 2.26 | 2.26 | 2.26 | 2.26 | 2.29 | 2.46 | 2.46 | 2.46 | 2.46 | |
| | S/T | 0.92 | 1.00 | 1.00 | 1.00 | 0.68 | 0.84 | 0.98 | 1.00 | 0.57 | 0.72 | 0.87 | 1.00 | 0.32 | 0.46 | 0.60 | 0.92 | |
| | PI | 0.81 | 0.81 | 0.81 | 0.81 | 0.81 | 0.81 | 0.81 | 0.81 | 0.81 | 0.81 | 0.81 | 0.81 | 0.81 | 0.82 | 0.82 | 0.82 | |
| 50 | TC | 1.94 | 1.97 | 2.00 | 2.03 | 2.06 | 2.06 | 2.09 | 2.11 | 2.14 | 2.14 | 2.17 | 2.20 | 2.31 | 2.31 | 2.31 | 2.31 | |
| | S/T | 0.95 | 1.00 | 1.00 | 1.00 | 0.70 | 0.86 | 1.00 | 1.00 | 0.58 | 0.74 | 0.89 | 1.00 | 0.32 | 0.46 | 0.61 | 0.97 | |
| | PI | 0.87 | 0.87 | 0.87 | 0.87 | 0.88 | 0.88 | 0.88 | 0.88 | 0.88 | 0.88 | 0.88 | 0.88 | 0.88 | 0.89 | 0.89 | 0.89 | |

TC:Total Cooling Capacity (kW)

S/T:Sensible Cooling Capacity Ratio

PI:Power Input(kW)

Note: The table shows the case where the operation frequency of a compressor is fixed.

| 42QHG012D8S+38QHG012D8S | | | | | | | | | | | | | | | | | | | |
|-------------------------|----------------|------------|------------|------|------|------|------|------|------|------|------|------|------|------|------|------|------|------|------|
| INDOOR AIRFLOW (CMH) | OUTDOOR DB(°C) | ID WB (°C) | 16.0 | | | | 18.0 | | | | 19.0 | | | | 22.0 | | | | |
| | | | ID DB (°C) | 23.0 | 25.0 | 27.0 | 30.0 | 23.0 | 25.0 | 27.0 | 30.0 | 23.0 | 25.0 | 27.0 | 30.0 | 23.0 | 25.0 | 27.0 | 30.0 |
| 350 | -15 | TC | 3.71 | 3.72 | 3.72 | 3.72 | 3.90 | 3.96 | 3.96 | 3.96 | 4.00 | 4.00 | 4.00 | 4.00 | 4.25 | 4.25 | 4.25 | 4.25 | |
| | | S/T | 0.67 | 0.72 | 0.79 | 0.85 | 0.55 | 0.61 | 0.67 | 0.73 | 0.49 | 0.55 | 0.62 | 0.68 | 0.38 | 0.42 | 0.48 | 0.54 | |
| | | PI | 0.72 | 0.73 | 0.73 | 0.72 | 0.72 | 0.72 | 0.72 | 0.72 | 0.72 | 0.72 | 0.72 | 0.72 | 0.72 | 0.72 | 0.72 | 0.72 | 0.72 |
| | -10 | TC | 3.68 | 3.70 | 3.70 | 3.70 | 3.87 | 3.93 | 3.93 | 3.93 | 3.98 | 3.98 | 3.98 | 3.98 | 4.23 | 4.23 | 4.23 | 4.23 | |
| | | S/T | 0.67 | 0.73 | 0.80 | 0.85 | 0.55 | 0.61 | 0.67 | 0.74 | 0.49 | 0.55 | 0.62 | 0.68 | 0.38 | 0.43 | 0.49 | 0.54 | |
| | | PI | 0.72 | 0.73 | 0.73 | 0.72 | 0.72 | 0.72 | 0.72 | 0.72 | 0.72 | 0.72 | 0.72 | 0.72 | 0.72 | 0.72 | 0.72 | 0.72 | 0.72 |
| | -5 | TC | 3.66 | 3.67 | 3.67 | 3.67 | 3.86 | 3.92 | 3.92 | 3.92 | 3.96 | 3.96 | 3.96 | 3.96 | 4.22 | 4.22 | 4.22 | 4.22 | |
| | | S/T | 0.67 | 0.73 | 0.80 | 0.86 | 0.56 | 0.62 | 0.67 | 0.74 | 0.50 | 0.56 | 0.62 | 0.68 | 0.38 | 0.43 | 0.49 | 0.55 | |
| | | PI | 0.72 | 0.72 | 0.72 | 0.72 | 0.72 | 0.72 | 0.72 | 0.72 | 0.72 | 0.72 | 0.72 | 0.72 | 0.72 | 0.72 | 0.72 | 0.72 | 0.72 |
| | 0 | TC | 3.64 | 3.66 | 3.66 | 3.66 | 3.85 | 3.91 | 3.91 | 3.91 | 3.95 | 3.95 | 3.95 | 3.95 | 4.22 | 4.22 | 4.22 | 4.22 | |
| | | S/T | 0.68 | 0.74 | 0.80 | 0.86 | 0.56 | 0.62 | 0.68 | 0.74 | 0.50 | 0.56 | 0.63 | 0.69 | 0.38 | 0.43 | 0.49 | 0.55 | |
| | | PI | 0.72 | 0.73 | 0.73 | 0.72 | 0.72 | 0.72 | 0.72 | 0.72 | 0.72 | 0.72 | 0.72 | 0.72 | 0.73 | 0.73 | 0.73 | 0.73 | |
| | 5 | TC | 3.62 | 3.64 | 3.64 | 3.64 | 3.83 | 3.89 | 3.89 | 3.89 | 3.94 | 3.94 | 3.94 | 3.94 | 4.21 | 4.21 | 4.21 | 4.21 | |
| | | S/T | 0.68 | 0.74 | 0.81 | 0.87 | 0.56 | 0.62 | 0.68 | 0.75 | 0.50 | 0.56 | 0.63 | 0.69 | 0.38 | 0.43 | 0.49 | 0.55 | |
| | | PI | 0.73 | 0.73 | 0.73 | 0.73 | 0.73 | 0.73 | 0.73 | 0.73 | 0.73 | 0.73 | 0.73 | 0.73 | 0.73 | 0.73 | 0.73 | 0.73 | 0.73 |
| | 10 | TC | 3.60 | 3.61 | 3.61 | 3.61 | 3.81 | 3.87 | 3.87 | 3.87 | 3.92 | 3.92 | 3.92 | 3.92 | 4.20 | 4.20 | 4.20 | 4.20 | |
| | | S/T | 0.68 | 0.74 | 0.81 | 0.87 | 0.56 | 0.62 | 0.68 | 0.75 | 0.50 | 0.56 | 0.63 | 0.69 | 0.39 | 0.44 | 0.50 | 0.55 | |
| | | PI | 0.74 | 0.75 | 0.75 | 0.74 | 0.74 | 0.74 | 0.74 | 0.74 | 0.74 | 0.74 | 0.74 | 0.74 | 0.74 | 0.74 | 0.74 | 0.74 | 0.74 |
| | 15 | TC | 3.57 | 3.59 | 3.59 | 3.59 | 3.79 | 3.85 | 3.85 | 3.85 | 3.90 | 3.90 | 3.90 | 3.90 | 4.19 | 4.19 | 4.19 | 4.19 | |
| | | S/T | 0.69 | 0.75 | 0.82 | 0.88 | 0.57 | 0.63 | 0.69 | 0.76 | 0.51 | 0.57 | 0.64 | 0.70 | 0.39 | 0.44 | 0.50 | 0.56 | |
| | | PI | 0.76 | 0.76 | 0.76 | 0.76 | 0.76 | 0.76 | 0.76 | 0.76 | 0.76 | 0.76 | 0.76 | 0.76 | 0.76 | 0.76 | 0.76 | 0.76 | 0.76 |
| | 20 | TC | 3.53 | 3.54 | 3.54 | 3.54 | 3.75 | 3.75 | 3.75 | 3.75 | 3.86 | 3.86 | 3.86 | 3.86 | 4.15 | 4.15 | 4.15 | 4.15 | |
| | | S/T | 0.69 | 0.75 | 0.82 | 0.88 | 0.57 | 0.63 | 0.69 | 0.76 | 0.51 | 0.57 | 0.64 | 0.70 | 0.39 | 0.44 | 0.50 | 0.56 | |
| | | PI | 0.79 | 0.79 | 0.79 | 0.79 | 0.78 | 0.78 | 0.78 | 0.78 | 0.78 | 0.78 | 0.78 | 0.78 | 0.78 | 0.78 | 0.78 | 0.78 | 0.78 |
| | 25 | TC | 3.37 | 3.37 | 3.37 | 3.40 | 3.57 | 3.57 | 3.57 | 3.57 | 3.69 | 3.69 | 3.69 | 3.69 | 3.98 | 3.98 | 3.98 | 3.98 | |
| | | S/T | 0.69 | 0.76 | 0.83 | 0.90 | 0.57 | 0.63 | 0.70 | 0.77 | 0.51 | 0.58 | 0.64 | 0.70 | 0.38 | 0.44 | 0.50 | 0.56 | |
| | | PI | 0.87 | 0.87 | 0.87 | 0.87 | 0.87 | 0.87 | 0.87 | 0.87 | 0.87 | 0.87 | 0.87 | 0.87 | 0.87 | 0.87 | 0.87 | 0.87 | 0.87 |
| | 30 | TC | 3.20 | 3.20 | 3.20 | 3.23 | 3.43 | 3.43 | 3.43 | 3.43 | 3.52 | 3.52 | 3.52 | 3.52 | 3.80 | 3.80 | 3.80 | 3.80 | |
| | | S/T | 0.70 | 0.77 | 0.84 | 0.91 | 0.57 | 0.64 | 0.71 | 0.78 | 0.51 | 0.58 | 0.65 | 0.71 | 0.38 | 0.44 | 0.50 | 0.56 | |
| | | PI | 0.95 | 0.95 | 0.95 | 0.95 | 0.95 | 0.95 | 0.95 | 0.95 | 0.95 | 0.95 | 0.95 | 0.95 | 0.96 | 0.96 | 0.96 | 0.96 | |
| | 35 | TC | 3.05 | 3.05 | 3.05 | 3.08 | 3.26 | 3.26 | 3.26 | 3.26 | 3.34 | 3.34 | 3.34 | 3.34 | 3.60 | 3.60 | 3.60 | 3.60 | |
| | | S/T | 0.70 | 0.78 | 0.86 | 0.93 | 0.57 | 0.64 | 0.72 | 0.79 | 0.51 | 0.58 | 0.65 | 0.72 | 0.37 | 0.44 | 0.50 | 0.57 | |
| | | PI | 1.03 | 1.03 | 1.03 | 1.03 | 1.04 | 1.04 | 1.04 | 1.04 | 1.04 | 1.04 | 1.04 | 1.04 | 1.05 | 1.05 | 1.05 | 1.05 | |
| | 40 | TC | 2.89 | 2.89 | 2.91 | 2.93 | 3.09 | 3.09 | 3.09 | 3.09 | 3.18 | 3.18 | 3.21 | 3.18 | 3.43 | 3.43 | 3.43 | 3.43 | |
| | | S/T | 0.72 | 0.80 | 0.88 | 0.96 | 0.58 | 0.66 | 0.74 | 0.82 | 0.51 | 0.59 | 0.67 | 0.74 | 0.37 | 0.44 | 0.51 | 0.58 | |
| | | PI | 1.13 | 1.13 | 1.13 | 1.13 | 1.14 | 1.14 | 1.14 | 1.14 | 1.14 | 1.14 | 1.14 | 1.14 | 1.15 | 1.15 | 1.15 | 1.15 | |
| | 46 | TC | 2.67 | 2.67 | 2.70 | 2.73 | 2.87 | 2.87 | 2.87 | 2.87 | 2.96 | 2.96 | 2.96 | 2.96 | 3.19 | 3.19 | 3.19 | 3.19 | |
| | | S/T | 0.73 | 0.81 | 0.90 | 0.98 | 0.58 | 0.66 | 0.75 | 0.83 | 0.51 | 0.59 | 0.67 | 0.75 | 0.36 | 0.44 | 0.51 | 0.58 | |
| | | PI | 1.26 | 1.26 | 1.26 | 1.26 | 1.27 | 1.27 | 1.27 | 1.27 | 1.27 | 1.27 | 1.27 | 1.27 | 1.28 | 1.28 | 1.28 | 1.28 | |
| | 50 | TC | 2.53 | 2.53 | 2.55 | 2.58 | 2.70 | 2.70 | 2.70 | 2.70 | 2.79 | 2.79 | 2.79 | 2.79 | 3.02 | 3.02 | 3.02 | 3.02 | |
| | | S/T | 0.74 | 0.83 | 0.92 | 1.00 | 0.59 | 0.67 | 0.76 | 0.85 | 0.52 | 0.60 | 0.69 | 0.77 | 0.36 | 0.44 | 0.51 | 0.59 | |
| | | PI | 1.37 | 1.37 | 1.37 | 1.37 | 1.38 | 1.38 | 1.38 | 1.38 | 1.38 | 1.38 | 1.38 | 1.38 | 1.39 | 1.39 | 1.39 | 1.39 | |
| | 400 | -15 | TC | 3.78 | 3.78 | 3.78 | 3.81 | 3.96 | 3.96 | 3.96 | 3.96 | 4.06 | 4.06 | 4.06 | 4.06 | 4.31 | 4.31 | 4.31 | 4.31 |
| | | | S/T | 0.68 | 0.74 | 0.98 | 1.00 | 0.55 | 0.62 | 0.69 | 0.75 | 0.49 | 0.56 | 0.63 | 0.70 | 0.36 | 0.42 | 0.48 | 0.55 |
| | | | PI | 0.74 | 0.74 | 0.74 | 0.74 | 0.74 | 0.74 | 0.74 | 0.74 | 0.74 | 0.74 | 0.74 | 0.74 | 0.74 | 0.74 | 0.74 | 0.74 |
| | | -10 | TC | 3.76 | 3.76 | 3.76 | 3.79 | 3.93 | 3.93 | 3.93 | 3.93 | 4.04 | 4.04 | 4.04 | 4.04 | 4.29 | 4.29 | 4.29 | 4.29 |
| | | | S/T | 0.68 | 0.75 | 0.99 | 1.00 | 0.55 | 0.62 | 0.69 | 0.76 | 0.49 | 0.56 | 0.63 | 0.70 | 0.36 | 0.43 | 0.49 | 0.55 |
| | | | PI | 0.74 | 0.74 | 0.74 | 0.74 | 0.74 | 0.74 | 0.74 | 0.74 | 0.74 | 0.74 | 0.74 | 0.74 | 0.74 | 0.74 | 0.74 | 0.74 |
| -5 | | TC | 3.73 | 3.73 | 3.73 | 3.76 | 3.92 | 3.92 | 3.92 | 3.92 | 4.02 | 4.02 | 4.02 | 4.02 | 4.28 | 4.28 | 4.28 | 4.28 | |
| | | S/T | 0.68 | 0.75 | 0.99 | 1.00 | 0.56 | 0.62 | 0.69 | 0.76 | 0.50 | 0.57 | 0.63 | 0.70 | 0.36 | 0.43 | 0.49 | 0.56 | |
| | | PI | 0.73 | 0.73 | 0.73 | 0.73 | 0.74 | 0.74 | 0.74 | 0.74 | 0.74 | 0.74 | 0.74 | 0.74 | 0.74 | 0.74 | 0.74 | 0.74 | |
| 0 | | TC | 3.72 | 3.72 | 3.72 | 3.75 | 3.91 | 3.91 | 3.91 | 3.91 | 4.01 | 4.01 | 4.01 | 4.01 | 4.28 | 4.28 | 4.28 | 4.28 | |
| | | S/T | 0.69 | 0.75 | 1.00 | 1.00 | 0.56 | 0.63 | 0.70 | 0.76 | 0.50 | 0.57 | 0.64 | 0.71 | 0.36 | 0.43 | 0.49 | 0.56 | |
| | | PI | 0.74 | 0.74 | 0.74 | 0.74 | 0.74 | 0.74 | 0.74 | 0.74 | 0.74 | 0.74 | 0.74 | 0.74 | 0.75 | 0.75 | 0.75 | 0.75 | |
| 5 | | TC | 3.70 | 3.70 | 3.70 | 3.73 | 3.89 | 3.89 | 3.89 | 3.89 | 4.00 | 4.00 | 4.00 | 4.00 | 4.27 | 4.27 | 4.27 | 4.27 | |
| | | S/T | 0.69 | 0.76 | 1.00 | 1.00 | 0.56 | 0.63 | 0.70 | 0.77 | 0.50 | 0.57 | 0.64 | 0.71 | 0.36 | 0.43 | 0.49 | 0.56 | |
| | | PI | 0.74 | 0.74 | 0.74 | 0.74 | 0.75 | 0.75 | 0.75 | 0.75 | 0.75 | 0.75 | 0.75 | 0.75 | 0.75 | 0.75 | 0.75 | 0.75 | |
| 10 | | TC | 3.67 | 3.67 | 3.67 | 3.70 | 3.87 | 3.87 | 3.87 | 3.87 | 3.98 | 3.98 | 3.98 | 3.98 | 4.26 | 4.26 | 4.26 | 4.26 | |
| | | S/T | 0.69 | 0.76 | 1.00 | 1.00 | 0.56 | 0.63 | 0.70 | 0.77 | 0.50 | 0.57 | 0.64 | 0.71 | 0.37 | 0.44 | 0.50 | 0.56 | |
| | | PI | 0.76 | 0.76 | 0.76 | 0.76 | 0.76 | 0.76 | 0.76 | 0.76 | 0.76 | 0.76 | 0.76 | 0.76 | 0.76 | 0.76 | 0.76 | 0.76 | |
| 15 | | TC | 3.64 | 3.64 | 3.64 | 3.67 | 3.85 | 3.85 | 3.85 | 3.85 | 3.96 | 3.96 | 3.96 | 3.96 | 4.25 | 4.25 | 4.25 | 4.25 | |
| | | S/T | 0.70 | 0.77 | 0.85 | 0.92 | 0.57 | 0.64 | 0.71 | 0.78 | 0.51 | 0.58 | 0.65 | 0.72 | 0.37 | 0.44 | 0.50 | 0.57 | |
| | | PI | 0.78 | 0.78 | 0.78 | 0.78 | 0.78 | 0.78 | 0.78 | 0.78 | 0.78 | 0.78 | 0.78 | 0.78 | 0.78 | 0.78 | 0.78 | 0.78 | |
| 20 | | TC | 3.60 | 3.60 | 3.60 | 3.63 | 3.81 | 3.81 | 3.81 | 3.81 | 3.92 | 3.92 | 3.92 | 3.92 | 4.21 | 4.21 | 4.21 | 4.21 | |
| | | S/T | 0.70 | 0.77 | 0.85 | 0.92 | 0.57 | 0.64 | 0.71 | 0.78 | 0.51 | 0.58 | 0.65 | 0.72 | 0.37 | 0.44 | 0.50 | 0.57 | |
| | | PI | 0.80 | 0.80 | 0.80 | 0.80 | 0.80 | 0.80 | 0.80 | 0.80 | 0.80 | 0.80 | 0.80 | 0.80 | 0.80 | 0.80 | 0.80 | 0.80 | |
| 25 | | TC | 3.43 | 3.43 | 3.43 | 3.46 | 3.63 | 3.63 | 3.63 | 3.63 | 3.75 | 3.75 | 3.75 | 3.75 | 4.04 | 4.04 | 4.04 | 4.04 | |

| | | | | | | | | | | | | | | | | | | |
|-----|-----|------|------|------|------|------|------|------|------|------|------|------|------|------|------|------|------|------|
| 530 | -15 | TC | 3.84 | 3.84 | 3.87 | 3.90 | 4.02 | 4.02 | 4.02 | 4.02 | 4.12 | 4.12 | 4.12 | 4.12 | 4.40 | 4.40 | 4.40 | 4.40 |
| | | S/T | 0.71 | 0.81 | 1.00 | 1.00 | 0.57 | 0.66 | 0.75 | 0.98 | 0.50 | 0.59 | 0.68 | 0.76 | 0.34 | 0.42 | 0.50 | 0.58 |
| | | PI | 0.76 | 0.76 | 0.76 | 0.76 | 0.76 | 0.76 | 0.76 | 0.76 | 0.76 | 0.76 | 0.76 | 0.76 | 0.76 | 0.75 | 0.75 | 0.75 |
| | -10 | TC | 3.82 | 3.82 | 3.85 | 3.88 | 3.99 | 3.99 | 3.99 | 3.99 | 4.10 | 4.10 | 4.10 | 4.10 | 4.38 | 4.38 | 4.38 | 4.38 |
| | | S/T | 0.72 | 0.82 | 1.00 | 1.00 | 0.57 | 0.66 | 0.76 | 0.98 | 0.50 | 0.59 | 0.68 | 0.77 | 0.34 | 0.43 | 0.50 | 0.58 |
| | | PI | 0.75 | 0.75 | 0.75 | 0.75 | 0.76 | 0.76 | 0.76 | 0.76 | 0.76 | 0.76 | 0.76 | 0.76 | 0.76 | 0.75 | 0.75 | 0.75 |
| | -5 | TC | 3.79 | 3.79 | 3.82 | 3.85 | 3.98 | 3.98 | 3.98 | 3.98 | 4.08 | 4.08 | 4.08 | 4.08 | 4.37 | 4.37 | 4.37 | 4.37 |
| | | S/T | 0.72 | 0.82 | 1.00 | 1.00 | 0.58 | 0.66 | 0.76 | 0.99 | 0.51 | 0.59 | 0.68 | 0.77 | 0.34 | 0.43 | 0.51 | 0.59 |
| | | PI | 0.75 | 0.75 | 0.75 | 0.75 | 0.76 | 0.76 | 0.76 | 0.76 | 0.76 | 0.76 | 0.76 | 0.76 | 0.76 | 0.75 | 0.75 | 0.75 |
| | 0 | TC | 3.77 | 3.77 | 3.80 | 3.83 | 3.96 | 3.96 | 3.96 | 3.96 | 4.07 | 4.07 | 4.07 | 4.07 | 4.37 | 4.37 | 4.37 | 4.37 |
| | | S/T | 0.73 | 0.82 | 1.00 | 1.00 | 0.58 | 0.67 | 0.76 | 0.99 | 0.51 | 0.60 | 0.69 | 0.77 | 0.34 | 0.43 | 0.51 | 0.59 |
| | | PI | 0.76 | 0.76 | 0.76 | 0.76 | 0.76 | 0.76 | 0.76 | 0.76 | 0.76 | 0.76 | 0.76 | 0.76 | 0.76 | 0.76 | 0.76 | 0.76 |
| | 5 | TC | 3.76 | 3.76 | 3.79 | 3.82 | 3.95 | 3.95 | 3.95 | 3.95 | 4.06 | 4.06 | 4.06 | 4.06 | 4.36 | 4.36 | 4.36 | 4.36 |
| | | S/T | 0.73 | 0.83 | 1.00 | 1.00 | 0.58 | 0.67 | 0.77 | 1.00 | 0.51 | 0.60 | 0.69 | 0.78 | 0.34 | 0.43 | 0.51 | 0.59 |
| | | PI | 0.76 | 0.76 | 0.76 | 0.76 | 0.77 | 0.77 | 0.77 | 0.77 | 0.77 | 0.77 | 0.77 | 0.77 | 0.76 | 0.76 | 0.76 | 0.76 |
| | 10 | TC | 3.73 | 3.73 | 3.76 | 3.79 | 3.93 | 3.93 | 3.93 | 3.93 | 4.04 | 4.04 | 4.04 | 4.04 | 4.35 | 4.35 | 4.35 | 4.35 |
| | | S/T | 0.73 | 0.83 | 1.00 | 1.00 | 0.58 | 0.67 | 0.77 | 1.00 | 0.51 | 0.60 | 0.69 | 0.78 | 0.35 | 0.44 | 0.51 | 0.59 |
| | | PI | 0.78 | 0.78 | 0.78 | 0.78 | 0.78 | 0.78 | 0.78 | 0.78 | 0.78 | 0.78 | 0.78 | 0.78 | 0.77 | 0.77 | 0.77 | 0.77 |
| 15 | TC | 3.70 | 3.70 | 3.73 | 3.76 | 3.90 | 3.90 | 3.90 | 3.90 | 4.02 | 4.02 | 4.02 | 4.02 | 4.33 | 4.33 | 4.33 | 4.33 | |
| | S/T | 0.74 | 0.84 | 0.94 | 1.00 | 0.59 | 0.68 | 0.78 | 0.87 | 0.52 | 0.61 | 0.70 | 0.79 | 0.35 | 0.44 | 0.52 | 0.60 | |
| | PI | 0.79 | 0.79 | 0.79 | 0.79 | 0.79 | 0.79 | 0.79 | 0.79 | 0.80 | 0.80 | 0.80 | 0.80 | 0.79 | 0.79 | 0.79 | 0.79 | |
| 20 | TC | 3.66 | 3.66 | 3.69 | 3.72 | 3.86 | 3.86 | 3.86 | 3.86 | 3.98 | 3.98 | 3.98 | 3.98 | 4.30 | 4.30 | 4.30 | 4.30 | |
| | S/T | 0.74 | 0.84 | 0.94 | 1.00 | 0.59 | 0.68 | 0.78 | 0.87 | 0.52 | 0.61 | 0.70 | 0.79 | 0.35 | 0.44 | 0.52 | 0.60 | |
| | PI | 0.82 | 0.82 | 0.82 | 0.82 | 0.82 | 0.82 | 0.82 | 0.82 | 0.82 | 0.82 | 0.82 | 0.82 | 0.81 | 0.81 | 0.81 | 0.81 | |
| 25 | TC | 3.49 | 3.49 | 3.52 | 3.55 | 3.69 | 3.69 | 3.69 | 3.72 | 3.81 | 3.81 | 3.81 | 3.81 | 4.09 | 4.09 | 4.09 | 4.09 | |
| | S/T | 0.76 | 0.86 | 0.96 | 1.00 | 0.60 | 0.69 | 0.79 | 0.88 | 0.52 | 0.62 | 0.71 | 0.80 | 0.35 | 0.44 | 0.52 | 0.61 | |
| | PI | 0.91 | 0.91 | 0.91 | 0.91 | 0.91 | 0.91 | 0.91 | 0.91 | 0.91 | 0.91 | 0.91 | 0.91 | 0.91 | 0.91 | 0.91 | 0.91 | |
| 30 | TC | 3.32 | 3.32 | 3.34 | 3.37 | 3.55 | 3.55 | 3.55 | 3.57 | 3.63 | 3.63 | 3.63 | 3.63 | 3.92 | 3.92 | 3.92 | 3.92 | |
| | S/T | 0.77 | 0.88 | 0.98 | 1.00 | 0.60 | 0.70 | 0.80 | 0.90 | 0.52 | 0.62 | 0.72 | 0.82 | 0.35 | 0.44 | 0.53 | 0.62 | |
| | PI | 1.00 | 1.00 | 1.00 | 1.00 | 1.00 | 1.00 | 1.00 | 1.00 | 1.00 | 1.00 | 1.00 | 1.00 | 1.00 | 1.00 | 1.00 | 1.00 | |
| 35 | TC | 3.14 | 3.17 | 3.20 | 3.23 | 3.37 | 3.37 | 3.37 | 3.40 | 3.46 | 3.46 | 3.52 | 3.46 | 3.75 | 3.75 | 3.75 | 3.75 | |
| | S/T | 0.78 | 0.89 | 1.00 | 1.00 | 0.61 | 0.71 | 0.82 | 0.92 | 0.53 | 0.63 | 0.73 | 0.84 | 0.34 | 0.44 | 0.53 | 0.63 | |
| | PI | 1.09 | 1.09 | 1.09 | 1.09 | 1.10 | 1.10 | 1.10 | 1.10 | 1.10 | 1.10 | 1.10 | 1.10 | 1.11 | 1.11 | 1.11 | 1.11 | |
| 40 | TC | 2.92 | 2.95 | 2.98 | 3.01 | 3.14 | 3.14 | 3.14 | 3.17 | 3.22 | 3.22 | 3.25 | 3.24 | 3.50 | 3.50 | 3.50 | 3.50 | |
| | S/T | 0.81 | 0.93 | 1.00 | 1.00 | 0.62 | 0.74 | 0.86 | 0.97 | 0.54 | 0.65 | 0.76 | 0.87 | 0.34 | 0.44 | 0.55 | 0.90 | |
| | PI | 1.21 | 1.21 | 1.21 | 1.21 | 1.22 | 1.22 | 1.22 | 1.22 | 1.22 | 1.22 | 1.22 | 1.22 | 1.23 | 1.23 | 1.23 | 1.23 | |
| 46 | TC | 2.71 | 2.73 | 2.76 | 2.79 | 2.90 | 2.90 | 2.90 | 2.93 | 2.99 | 2.99 | 2.99 | 3.02 | 3.25 | 3.25 | 3.25 | 3.25 | |
| | S/T | 0.83 | 0.95 | 1.00 | 1.00 | 0.63 | 0.75 | 0.87 | 0.99 | 0.54 | 0.66 | 0.78 | 0.89 | 0.34 | 0.44 | 0.55 | 0.92 | |
| | PI | 1.34 | 1.34 | 1.34 | 1.34 | 1.35 | 1.35 | 1.35 | 1.35 | 1.35 | 1.35 | 1.35 | 1.35 | 1.37 | 1.37 | 1.37 | 1.37 | |
| 50 | TC | 2.56 | 2.59 | 2.62 | 2.65 | 2.73 | 2.73 | 2.76 | 2.79 | 2.82 | 2.82 | 2.82 | 2.85 | 3.05 | 3.05 | 3.05 | 3.05 | |
| | S/T | 0.85 | 0.98 | 1.00 | 1.00 | 0.64 | 0.77 | 0.89 | 1.00 | 0.55 | 0.67 | 0.80 | 0.92 | 0.33 | 0.45 | 0.56 | 0.97 | |
| | PI | 1.46 | 1.46 | 1.46 | 1.46 | 1.46 | 1.46 | 1.46 | 1.46 | 1.47 | 1.47 | 1.47 | 1.47 | 1.48 | 1.48 | 1.48 | 1.48 | |

TC:Total Cooling Capacity (kW)

S/T:Sensible Cooling Capacity Ratio

PI:Power Input(kW)

Note: The table shows the case where the operation frequency of a compressor is fixed.

| 42QH012D85H+38QH012D85H | | | | | | | | | | | | | | | | | | | |
|-------------------------|---------------|-----------|-----------|------|------|------|------|------|------|------|------|------|------|------|------|------|------|------|------|
| INDOOR AIRFLOW (CMH) | OUTDOOR DB(C) | ID WB (C) | 16.0 | | | | 18.0 | | | | 19.0 | | | | 22.0 | | | | |
| | | | ID DB (C) | 23.0 | 25.0 | 27.0 | 30.0 | 23.0 | 25.0 | 27.0 | 30.0 | 23.0 | 25.0 | 27.0 | 30.0 | 23.0 | 25.0 | 27.0 | 30.0 |
| 310 | -15 | TC | 3.71 | 3.72 | 3.72 | 3.72 | 3.90 | 3.96 | 3.96 | 3.96 | 4.00 | 4.00 | 4.00 | 4.00 | 4.25 | 4.25 | 4.25 | 4.25 | |
| | | S/T | 0.66 | 0.71 | 0.76 | 0.82 | 0.55 | 0.60 | 0.66 | 0.71 | 0.50 | 0.55 | 0.61 | 0.66 | 0.39 | 0.43 | 0.48 | 0.53 | |
| | | PI | 0.66 | 0.67 | 0.67 | 0.66 | 0.66 | 0.66 | 0.66 | 0.66 | 0.66 | 0.66 | 0.66 | 0.66 | 0.66 | 0.66 | 0.66 | 0.66 | 0.66 |
| | -10 | TC | 3.68 | 3.70 | 3.70 | 3.70 | 3.87 | 3.93 | 3.93 | 3.93 | 3.98 | 3.98 | 3.98 | 3.98 | 4.23 | 4.23 | 4.23 | 4.23 | |
| | | S/T | 0.66 | 0.72 | 0.77 | 0.82 | 0.55 | 0.61 | 0.66 | 0.72 | 0.50 | 0.55 | 0.61 | 0.66 | 0.39 | 0.44 | 0.49 | 0.53 | |
| | | PI | 0.66 | 0.66 | 0.66 | 0.66 | 0.66 | 0.66 | 0.66 | 0.66 | 0.66 | 0.66 | 0.66 | 0.66 | 0.66 | 0.66 | 0.66 | 0.66 | 0.66 |
| | -5 | TC | 3.66 | 3.67 | 3.67 | 3.67 | 3.86 | 3.92 | 3.92 | 3.92 | 3.96 | 3.96 | 3.96 | 3.96 | 4.22 | 4.22 | 4.22 | 4.22 | |
| | | S/T | 0.66 | 0.72 | 0.77 | 0.83 | 0.56 | 0.61 | 0.66 | 0.72 | 0.51 | 0.56 | 0.61 | 0.66 | 0.39 | 0.44 | 0.49 | 0.54 | |
| | | PI | 0.66 | 0.66 | 0.66 | 0.66 | 0.65 | 0.65 | 0.65 | 0.65 | 0.66 | 0.66 | 0.66 | 0.66 | 0.66 | 0.66 | 0.66 | 0.66 | 0.66 |
| | 0 | TC | 3.64 | 3.66 | 3.66 | 3.66 | 3.85 | 3.91 | 3.91 | 3.91 | 3.95 | 3.95 | 3.95 | 3.95 | 4.22 | 4.22 | 4.22 | 4.22 | |
| | | S/T | 0.67 | 0.73 | 0.77 | 0.83 | 0.56 | 0.61 | 0.67 | 0.73 | 0.51 | 0.56 | 0.62 | 0.67 | 0.39 | 0.44 | 0.49 | 0.54 | |
| | | PI | 0.66 | 0.66 | 0.66 | 0.66 | 0.66 | 0.66 | 0.66 | 0.66 | 0.66 | 0.66 | 0.66 | 0.66 | 0.66 | 0.66 | 0.66 | 0.66 | 0.66 |
| | 5 | TC | 3.62 | 3.64 | 3.64 | 3.64 | 3.83 | 3.89 | 3.89 | 3.89 | 3.94 | 3.94 | 3.94 | 3.94 | 4.21 | 4.21 | 4.21 | 4.21 | |
| | | S/T | 0.67 | 0.73 | 0.78 | 0.84 | 0.56 | 0.62 | 0.67 | 0.73 | 0.51 | 0.56 | 0.62 | 0.67 | 0.39 | 0.44 | 0.49 | 0.54 | |
| | | PI | 0.67 | 0.67 | 0.67 | 0.67 | 0.66 | 0.66 | 0.66 | 0.66 | 0.66 | 0.66 | 0.66 | 0.66 | 0.67 | 0.67 | 0.67 | 0.67 | 0.67 |
| | 10 | TC | 3.60 | 3.61 | 3.61 | 3.61 | 3.81 | 3.87 | 3.87 | 3.87 | 3.92 | 3.92 | 3.92 | 3.92 | 4.20 | 4.20 | 4.20 | 4.20 | |
| | | S/T | 0.67 | 0.73 | 0.78 | 0.84 | 0.56 | 0.62 | 0.67 | 0.73 | 0.51 | 0.56 | 0.62 | 0.67 | 0.40 | 0.45 | 0.50 | 0.54 | |
| | | PI | 0.68 | 0.68 | 0.68 | 0.68 | 0.67 | 0.67 | 0.67 | 0.67 | 0.67 | 0.67 | 0.67 | 0.67 | 0.68 | 0.68 | 0.68 | 0.68 | 0.68 |
| | 15 | TC | 3.57 | 3.59 | 3.59 | 3.59 | 3.79 | 3.85 | 3.85 | 3.85 | 3.90 | 3.90 | 3.90 | 3.90 | 4.19 | 4.19 | 4.19 | 4.19 | |
| | | S/T | 0.68 | 0.74 | 0.79 | 0.85 | 0.57 | 0.62 | 0.68 | 0.74 | 0.52 | 0.57 | 0.63 | 0.68 | 0.40 | 0.45 | 0.50 | 0.55 | |
| | | PI | 0.70 | 0.70 | 0.70 | 0.70 | 0.69 | 0.69 | 0.69 | 0.69 | 0.69 | 0.69 | 0.69 | 0.69 | 0.69 | 0.69 | 0.69 | 0.69 | 0.69 |
| | 20 | TC | 3.53 | 3.54 | 3.54 | 3.54 | 3.75 | 3.75 | 3.75 | 3.75 | 3.86 | 3.86 | 3.86 | 3.86 | 4.15 | 4.15 | 4.15 | 4.15 | |
| | | S/T | 0.68 | 0.74 | 0.79 | 0.85 | 0.57 | 0.63 | 0.68 | 0.74 | 0.52 | 0.57 | 0.63 | 0.68 | 0.40 | 0.45 | 0.50 | 0.55 | |
| | | PI | 0.72 | 0.72 | 0.72 | 0.72 | 0.71 | 0.71 | 0.71 | 0.71 | 0.71 | 0.71 | 0.71 | 0.71 | 0.71 | 0.71 | 0.71 | 0.71 | 0.71 |
| | 25 | TC | 3.37 | 3.37 | 3.37 | 3.37 | 3.57 | 3.57 | 3.57 | 3.57 | 3.69 | 3.69 | 3.69 | 3.69 | 3.98 | 3.98 | 3.98 | 3.98 | |
| | | S/T | 0.68 | 0.74 | 0.80 | 0.86 | 0.57 | 0.63 | 0.68 | 0.74 | 0.52 | 0.57 | 0.63 | 0.69 | 0.40 | 0.45 | 0.50 | 0.55 | |
| | | PI | 0.79 | 0.79 | 0.79 | 0.79 | 0.79 | 0.79 | 0.79 | 0.79 | 0.79 | 0.79 | 0.79 | 0.79 | 0.79 | 0.79 | 0.79 | 0.79 | 0.79 |
| | 30 | TC | 3.20 | 3.20 | 3.20 | 3.20 | 3.43 | 3.43 | 3.43 | 3.43 | 3.52 | 3.52 | 3.52 | 3.52 | 3.80 | 3.80 | 3.80 | 3.80 | |
| | | S/T | 0.68 | 0.75 | 0.81 | 0.88 | 0.57 | 0.63 | 0.69 | 0.75 | 0.51 | 0.57 | 0.63 | 0.69 | 0.39 | 0.44 | 0.50 | 0.55 | |
| | | PI | 0.87 | 0.87 | 0.87 | 0.87 | 0.87 | 0.87 | 0.87 | 0.87 | 0.87 | 0.87 | 0.87 | 0.87 | 0.88 | 0.88 | 0.88 | 0.88 | 0.88 |
| | 35 | TC | 3.05 | 3.05 | 3.05 | 3.08 | 3.26 | 3.26 | 3.26 | 3.26 | 3.34 | 3.34 | 3.34 | 3.34 | 3.60 | 3.60 | 3.60 | 3.60 | |
| | | S/T | 0.69 | 0.76 | 0.82 | 0.89 | 0.57 | 0.63 | 0.70 | 0.76 | 0.51 | 0.58 | 0.64 | 0.70 | 0.38 | 0.44 | 0.50 | 0.56 | |
| | | PI | 0.95 | 0.95 | 0.95 | 0.95 | 0.96 | 0.96 | 0.96 | 0.96 | 0.96 | 0.96 | 0.96 | 0.96 | 0.96 | 0.96 | 0.96 | 0.96 | 0.96 |
| | 40 | TC | 2.89 | 2.89 | 2.89 | 2.92 | 3.09 | 3.09 | 3.09 | 3.09 | 3.18 | 3.18 | 3.21 | 3.18 | 3.43 | 3.43 | 3.43 | 3.43 | |
| | | S/T | 0.70 | 0.77 | 0.85 | 0.92 | 0.57 | 0.64 | 0.71 | 0.78 | 0.51 | 0.58 | 0.65 | 0.72 | 0.38 | 0.44 | 0.50 | 0.56 | |
| | | PI | 1.04 | 1.04 | 1.04 | 1.04 | 1.05 | 1.05 | 1.05 | 1.05 | 1.05 | 1.05 | 1.05 | 1.05 | 1.06 | 1.06 | 1.06 | 1.06 | |
| | 46 | TC | 2.67 | 2.67 | 2.67 | 2.70 | 2.87 | 2.87 | 2.87 | 2.87 | 2.96 | 2.96 | 2.96 | 2.96 | 3.19 | 3.19 | 3.19 | 3.19 | |
| | | S/T | 0.70 | 0.78 | 0.86 | 0.94 | 0.57 | 0.65 | 0.72 | 0.79 | 0.51 | 0.58 | 0.65 | 0.72 | 0.37 | 0.44 | 0.50 | 0.57 | |
| | | PI | 1.16 | 1.16 | 1.16 | 1.16 | 1.17 | 1.17 | 1.17 | 1.17 | 1.17 | 1.17 | 1.17 | 1.17 | 1.18 | 1.18 | 1.18 | 1.18 | |
| | 50 | TC | 2.53 | 2.53 | 2.53 | 2.55 | 2.70 | 2.70 | 2.70 | 2.70 | 2.79 | 2.79 | 2.79 | 2.79 | 3.02 | 3.02 | 3.02 | 3.02 | |
| | | S/T | 0.71 | 0.80 | 0.88 | 0.96 | 0.58 | 0.65 | 0.73 | 0.81 | 0.51 | 0.59 | 0.66 | 0.74 | 0.37 | 0.44 | 0.51 | 0.58 | |
| | | PI | 1.26 | 1.26 | 1.26 | 1.26 | 1.27 | 1.27 | 1.27 | 1.27 | 1.27 | 1.27 | 1.27 | 1.27 | 1.28 | 1.28 | 1.28 | 1.28 | |
| | 370 | -15 | TC | 3.78 | 3.78 | 3.78 | 3.81 | 3.96 | 3.96 | 3.96 | 3.96 | 4.06 | 4.06 | 4.06 | 4.06 | 4.31 | 4.31 | 4.31 | 4.31 |
| | | | S/T | 0.67 | 0.73 | 0.98 | 1.00 | 0.55 | 0.61 | 0.68 | 0.73 | 0.49 | 0.56 | 0.62 | 0.68 | 0.37 | 0.42 | 0.48 | 0.54 |
| | | | PI | 0.69 | 0.69 | 0.69 | 0.69 | 0.68 | 0.68 | 0.68 | 0.68 | 0.68 | 0.68 | 0.68 | 0.68 | 0.68 | 0.68 | 0.68 | 0.68 |
| | | -10 | TC | 3.76 | 3.76 | 3.76 | 3.79 | 3.93 | 3.93 | 3.93 | 3.93 | 4.04 | 4.04 | 4.04 | 4.04 | 4.29 | 4.29 | 4.29 | 4.29 |
| | | | S/T | 0.67 | 0.74 | 0.99 | 1.00 | 0.55 | 0.61 | 0.68 | 0.74 | 0.49 | 0.56 | 0.62 | 0.68 | 0.37 | 0.43 | 0.49 | 0.54 |
| | | | PI | 0.69 | 0.69 | 0.69 | 0.69 | 0.68 | 0.68 | 0.68 | 0.68 | 0.68 | 0.68 | 0.68 | 0.68 | 0.68 | 0.68 | 0.68 | 0.68 |
| -5 | | TC | 3.73 | 3.73 | 3.73 | 3.76 | 3.92 | 3.92 | 3.92 | 3.92 | 4.02 | 4.02 | 4.02 | 4.02 | 4.28 | 4.28 | 4.28 | 4.28 | |
| | | S/T | 0.67 | 0.74 | 0.99 | 1.00 | 0.56 | 0.61 | 0.68 | 0.74 | 0.50 | 0.57 | 0.62 | 0.68 | 0.37 | 0.43 | 0.49 | 0.55 | |
| | | PI | 0.68 | 0.68 | 0.68 | 0.68 | 0.68 | 0.68 | 0.68 | 0.68 | 0.68 | 0.68 | 0.68 | 0.68 | 0.69 | 0.69 | 0.69 | 0.69 | |
| 0 | | TC | 3.72 | 3.72 | 3.72 | 3.75 | 3.91 | 3.91 | 3.91 | 3.91 | 4.01 | 4.01 | 4.01 | 4.01 | 4.28 | 4.28 | 4.28 | 4.28 | |
| | | S/T | 0.68 | 0.74 | 1.00 | 1.00 | 0.56 | 0.62 | 0.69 | 0.74 | 0.50 | 0.57 | 0.63 | 0.69 | 0.37 | 0.43 | 0.49 | 0.55 | |
| | | PI | 0.69 | 0.69 | 0.69 | 0.69 | 0.68 | 0.68 | 0.68 | 0.68 | 0.68 | 0.68 | 0.68 | 0.68 | 0.69 | 0.69 | 0.69 | 0.69 | |
| 5 | | TC | 3.70 | 3.70 | 3.70 | 3.73 | 3.89 | 3.89 | 3.89 | 3.89 | 4.00 | 4.00 | 4.00 | 4.00 | 4.27 | 4.27 | 4.27 | 4.27 | |
| | | S/T | 0.68 | 0.75 | 1.00 | 1.00 | 0.56 | 0.62 | 0.69 | 0.75 | 0.50 | 0.57 | 0.63 | 0.69 | 0.37 | 0.43 | 0.49 | 0.55 | |
| | | PI | 0.69 | 0.69 | 0.69 | 0.69 | 0.69 | 0.69 | 0.69 | 0.69 | 0.69 | 0.69 | 0.69 | 0.69 | 0.69 | 0.69 | 0.69 | 0.69 | |
| 10 | | TC | 3.67 | 3.67 | 3.67 | 3.70 | 3.87 | 3.87 | 3.87 | 3.87 | 3.98 | 3.98 | 3.98 | 3.98 | 4.26 | 4.26 | 4.26 | 4.26 | |
| | | S/T | 0.68 | 0.75 | 1.00 | 1.00 | 0.56 | 0.62 | 0.69 | 0.75 | 0.50 | 0.57 | 0.63 | 0.69 | 0.38 | 0.44 | 0.50 | 0.55 | |
| | | PI | 0.71 | 0.71 | 0.71 | 0.71 | 0.70 | 0.70 | 0.70 | 0.70 | 0.70 | 0.70 | 0.70 | 0.70 | 0.70 | 0.70 | 0.70 | 0.70 | |
| 15 | | TC | 3.64 | 3.64 | 3.64 | 3.67 | 3.85 | 3.85 | 3.85 | 3.85 | 3.96 | 3.96 | 3.96 | 3.96 | 4.25 | 4.25 | 4.25 | 4.25 | |
| | | S/T | 0.69 | 0.76 | 0.83 | 0.89 | 0.57 | 0.63 | 0.70 | 0.76 | 0.51 | 0.58 | 0.64 | 0.70 | 0.38 | 0.44 | 0.50 | 0.56 | |
| | | PI | 0.72 | 0.72 | 0.72 | 0.72 | 0.71 | 0.71 | 0.71 | 0.71 | 0.71 | 0.71 | 0.71 | 0.71 | 0.72 | 0.72 | 0.72 | 0.72 | |
| 20 | | TC | 3.60 | 3.60 | 3.60 | 3.63 | 3.81 | 3.81 | 3.81 | 3.81 | 3.92 | 3.92 | 3.92 | 3.92 | 4.21 | 4.21 | 4.21 | 4.21 | |
| | | S/T | 0.69 | 0.76 | 0.83 | 0.89 | 0.57 | 0.63 | 0.70 | 0.76 | 0.51 | 0.58 | 0.64 | 0.70 | 0.38 | 0.44 | 0.50 | 0.56 | |
| | | PI | 0.75 | 0.75 | 0.75 | 0.75 | 0.74 | 0.74 | 0.74 | 0.74 | 0.74 | 0.74 | 0.74 | 0.74 | 0.74 | 0.74 | 0.74 | 0.74 | |
| 25 | | TC | 3.43 | 3.43 | 3.43 | 3.46 | 3.63 | 3.63 | 3.63 | 3.63 | 3.75 | 3.75 | 3.75 | 3.75 | | | | | |

| | | | | | | | | | | | | | | | | | | |
|-----|-----|------|------|------|------|------|------|------|------|------|------|------|------|------|------|------|------|------|
| 520 | -15 | TC | 3.84 | 3.84 | 3.87 | 3.90 | 4.02 | 4.02 | 4.02 | 4.02 | 4.12 | 4.12 | 4.12 | 4.12 | 4.40 | 4.40 | 4.40 | 4.40 |
| | | S/T | 0.71 | 0.81 | 1.00 | 1.00 | 0.57 | 0.66 | 0.74 | 0.98 | 0.50 | 0.59 | 0.67 | 0.75 | 0.35 | 0.42 | 0.50 | 0.58 |
| | | PI | 0.70 | 0.70 | 0.70 | 0.70 | 0.69 | 0.69 | 0.69 | 0.69 | 0.69 | 0.69 | 0.69 | 0.69 | 0.69 | 0.69 | 0.69 | 0.69 |
| | -10 | TC | 3.82 | 3.82 | 3.85 | 3.88 | 3.99 | 3.99 | 3.99 | 3.99 | 4.10 | 4.10 | 4.10 | 4.10 | 4.38 | 4.38 | 4.38 | 4.38 |
| | | S/T | 0.72 | 0.82 | 1.00 | 1.00 | 0.57 | 0.66 | 0.75 | 0.98 | 0.50 | 0.59 | 0.67 | 0.76 | 0.35 | 0.43 | 0.50 | 0.58 |
| | | PI | 0.69 | 0.69 | 0.69 | 0.69 | 0.69 | 0.69 | 0.69 | 0.69 | 0.69 | 0.69 | 0.69 | 0.69 | 0.69 | 0.69 | 0.69 | 0.69 |
| | -5 | TC | 3.79 | 3.79 | 3.82 | 3.85 | 3.98 | 3.98 | 3.98 | 3.98 | 4.08 | 4.08 | 4.08 | 4.08 | 4.37 | 4.37 | 4.37 | 4.37 |
| | | S/T | 0.72 | 0.82 | 1.00 | 1.00 | 0.58 | 0.66 | 0.75 | 0.99 | 0.51 | 0.59 | 0.67 | 0.76 | 0.35 | 0.43 | 0.51 | 0.59 |
| | | PI | 0.69 | 0.69 | 0.69 | 0.69 | 0.69 | 0.69 | 0.69 | 0.69 | 0.69 | 0.69 | 0.69 | 0.69 | 0.69 | 0.69 | 0.69 | 0.69 |
| | 0 | TC | 3.77 | 3.77 | 3.80 | 3.83 | 3.96 | 3.96 | 3.96 | 3.96 | 4.07 | 4.07 | 4.07 | 4.07 | 4.37 | 4.37 | 4.37 | 4.37 |
| | | S/T | 0.73 | 0.82 | 1.00 | 1.00 | 0.58 | 0.67 | 0.75 | 0.99 | 0.51 | 0.60 | 0.68 | 0.76 | 0.35 | 0.43 | 0.51 | 0.59 |
| | | PI | 0.70 | 0.70 | 0.70 | 0.70 | 0.69 | 0.69 | 0.69 | 0.69 | 0.69 | 0.69 | 0.69 | 0.69 | 0.70 | 0.70 | 0.70 | 0.70 |
| | 5 | TC | 3.76 | 3.76 | 3.79 | 3.82 | 3.95 | 3.95 | 3.95 | 3.95 | 4.06 | 4.06 | 4.06 | 4.06 | 4.36 | 4.36 | 4.36 | 4.36 |
| | | S/T | 0.73 | 0.83 | 1.00 | 1.00 | 0.58 | 0.67 | 0.76 | 1.00 | 0.51 | 0.60 | 0.68 | 0.77 | 0.35 | 0.43 | 0.51 | 0.59 |
| | | PI | 0.70 | 0.70 | 0.70 | 0.70 | 0.70 | 0.70 | 0.70 | 0.70 | 0.70 | 0.70 | 0.70 | 0.70 | 0.70 | 0.70 | 0.70 | 0.70 |
| | 10 | TC | 3.73 | 3.73 | 3.76 | 3.79 | 3.93 | 3.93 | 3.93 | 3.93 | 4.04 | 4.04 | 4.04 | 4.04 | 4.35 | 4.35 | 4.35 | 4.35 |
| | | S/T | 0.73 | 0.83 | 1.00 | 1.00 | 0.58 | 0.67 | 0.76 | 1.00 | 0.51 | 0.60 | 0.68 | 0.77 | 0.36 | 0.44 | 0.51 | 0.59 |
| | | PI | 0.72 | 0.72 | 0.72 | 0.72 | 0.71 | 0.71 | 0.71 | 0.71 | 0.71 | 0.71 | 0.71 | 0.71 | 0.71 | 0.71 | 0.71 | 0.71 |
| 15 | TC | 3.70 | 3.70 | 3.73 | 3.76 | 3.90 | 3.90 | 3.90 | 3.90 | 4.02 | 4.02 | 4.02 | 4.02 | 4.33 | 4.33 | 4.33 | 4.33 | |
| | S/T | 0.74 | 0.84 | 0.93 | 1.00 | 0.59 | 0.68 | 0.77 | 0.86 | 0.52 | 0.61 | 0.69 | 0.78 | 0.36 | 0.44 | 0.52 | 0.60 | |
| | PI | 0.73 | 0.73 | 0.73 | 0.73 | 0.72 | 0.72 | 0.72 | 0.72 | 0.72 | 0.72 | 0.72 | 0.72 | 0.73 | 0.73 | 0.73 | 0.73 | |
| 20 | TC | 3.66 | 3.66 | 3.69 | 3.72 | 3.86 | 3.86 | 3.86 | 3.86 | 3.98 | 3.98 | 3.98 | 3.98 | 4.30 | 4.30 | 4.30 | 4.30 | |
| | S/T | 0.74 | 0.84 | 0.93 | 1.00 | 0.59 | 0.68 | 0.77 | 0.86 | 0.52 | 0.61 | 0.69 | 0.78 | 0.36 | 0.44 | 0.52 | 0.60 | |
| | PI | 0.76 | 0.76 | 0.76 | 0.76 | 0.75 | 0.75 | 0.75 | 0.75 | 0.75 | 0.75 | 0.75 | 0.75 | 0.75 | 0.75 | 0.75 | 0.75 | |
| 25 | TC | 3.49 | 3.49 | 3.52 | 3.55 | 3.69 | 3.69 | 3.69 | 3.69 | 3.81 | 3.81 | 3.81 | 3.81 | 4.09 | 4.09 | 4.09 | 4.09 | |
| | S/T | 0.75 | 0.85 | 0.95 | 1.00 | 0.59 | 0.69 | 0.78 | 0.88 | 0.52 | 0.61 | 0.70 | 0.80 | 0.35 | 0.44 | 0.52 | 0.61 | |
| | PI | 0.84 | 0.84 | 0.84 | 0.84 | 0.84 | 0.84 | 0.84 | 0.84 | 0.84 | 0.84 | 0.84 | 0.84 | 0.84 | 0.84 | 0.84 | 0.84 | |
| 30 | TC | 3.32 | 3.32 | 3.34 | 3.37 | 3.55 | 3.55 | 3.55 | 3.57 | 3.63 | 3.63 | 3.63 | 3.63 | 3.92 | 3.92 | 3.92 | 3.92 | |
| | S/T | 0.76 | 0.87 | 0.97 | 1.00 | 0.60 | 0.70 | 0.80 | 0.89 | 0.52 | 0.62 | 0.72 | 0.81 | 0.35 | 0.44 | 0.53 | 0.62 | |
| | PI | 0.92 | 0.92 | 0.92 | 0.92 | 0.92 | 0.92 | 0.92 | 0.92 | 0.92 | 0.92 | 0.92 | 0.92 | 0.92 | 0.92 | 0.92 | 0.92 | |
| 35 | TC | 3.14 | 3.17 | 3.20 | 3.23 | 3.37 | 3.37 | 3.37 | 3.40 | 3.46 | 3.46 | 3.46 | 3.52 | 3.46 | 3.75 | 3.75 | 3.75 | |
| | S/T | 0.78 | 0.89 | 0.99 | 1.00 | 0.61 | 0.71 | 0.81 | 0.91 | 0.53 | 0.63 | 0.72 | 0.83 | 0.35 | 0.44 | 0.53 | 0.63 | |
| | PI | 0.99 | 0.99 | 0.99 | 0.99 | 1.00 | 1.00 | 1.00 | 1.00 | 1.00 | 1.00 | 1.00 | 1.00 | 1.01 | 1.01 | 1.01 | 1.01 | |
| 40 | TC | 2.92 | 2.95 | 2.98 | 3.01 | 3.14 | 3.14 | 3.14 | 3.17 | 3.22 | 3.22 | 3.25 | 3.24 | 3.50 | 3.50 | 3.50 | 3.50 | |
| | S/T | 0.80 | 0.92 | 1.00 | 1.00 | 0.62 | 0.73 | 0.85 | 0.96 | 0.53 | 0.64 | 0.75 | 0.87 | 0.34 | 0.44 | 0.55 | 0.90 | |
| | PI | 1.10 | 1.10 | 1.10 | 1.10 | 1.11 | 1.11 | 1.11 | 1.11 | 1.11 | 1.11 | 1.11 | 1.11 | 1.12 | 1.12 | 1.12 | 1.12 | |
| 46 | TC | 2.71 | 2.73 | 2.76 | 2.79 | 2.90 | 2.90 | 2.90 | 2.93 | 2.99 | 2.99 | 2.99 | 3.02 | 3.25 | 3.25 | 3.25 | 3.25 | |
| | S/T | 0.82 | 0.94 | 1.00 | 1.00 | 0.63 | 0.75 | 0.86 | 0.98 | 0.54 | 0.65 | 0.77 | 0.88 | 0.34 | 0.44 | 0.55 | 0.92 | |
| | PI | 1.22 | 1.22 | 1.22 | 1.22 | 1.23 | 1.23 | 1.23 | 1.23 | 1.23 | 1.23 | 1.23 | 1.23 | 1.24 | 1.24 | 1.24 | 1.24 | |
| 50 | TC | 2.56 | 2.59 | 2.62 | 2.65 | 2.73 | 2.73 | 2.76 | 2.79 | 2.82 | 2.82 | 2.82 | 2.85 | 3.05 | 3.05 | 3.05 | 3.05 | |
| | S/T | 0.84 | 0.97 | 1.00 | 1.00 | 0.64 | 0.76 | 0.89 | 1.00 | 0.54 | 0.67 | 0.79 | 0.91 | 0.33 | 0.45 | 0.56 | 0.97 | |
| | PI | 1.33 | 1.33 | 1.33 | 1.33 | 1.33 | 1.33 | 1.33 | 1.33 | 1.34 | 1.34 | 1.34 | 1.34 | 1.35 | 1.35 | 1.35 | 1.35 | |

TC:Total Cooling Capacity (kW)

S/T:Sensible Cooling Capacity Ratio

PI:Power Input(kW)

Note: The table shows the case where the operation frequency of a compressor is fixed.

| 42QH018D8S+38QH018D8S | | | | | | | | | | | | | | | | | | | |
|-----------------------|----------------|------------|------------|------|------|------|------|------|------|------|------|------|------|------|------|------|------|------|------|
| INDOOR AIRFLOW (CMH) | OUTDOOR DB(°C) | ID WB (°C) | 16.0 | | | | 18.0 | | | | 19.0 | | | | 22.0 | | | | |
| | | | ID DB (°C) | 23.0 | 25.0 | 27.0 | 30.0 | 23.0 | 25.0 | 27.0 | 30.0 | 23.0 | 25.0 | 27.0 | 30.0 | 23.0 | 25.0 | 27.0 | 30.0 |
| 500 | -15 | TC | 5.50 | 5.50 | 5.50 | 5.50 | 5.78 | 5.90 | 5.90 | 5.90 | 5.93 | 5.93 | 5.93 | 5.93 | 6.28 | 6.28 | 6.28 | 6.28 | |
| | | S/T | 0.66 | 0.72 | 0.78 | 0.84 | 0.55 | 0.61 | 0.67 | 0.72 | 0.49 | 0.55 | 0.61 | 0.67 | 0.38 | 0.42 | 0.48 | 0.53 | |
| | | PI | 1.03 | 1.03 | 1.03 | 1.03 | 1.03 | 1.03 | 1.03 | 1.03 | 1.03 | 1.03 | 1.03 | 1.03 | 1.03 | 1.03 | 1.03 | 1.03 | 1.03 |
| | -10 | TC | 5.46 | 5.47 | 5.47 | 5.47 | 5.75 | 5.87 | 5.87 | 5.87 | 5.90 | 5.90 | 5.90 | 5.90 | 6.25 | 6.25 | 6.25 | 6.25 | |
| | | S/T | 0.66 | 0.73 | 0.79 | 0.84 | 0.55 | 0.61 | 0.67 | 0.73 | 0.49 | 0.55 | 0.61 | 0.67 | 0.38 | 0.43 | 0.49 | 0.53 | |
| | | PI | 1.03 | 1.02 | 1.02 | 1.03 | 1.03 | 1.03 | 1.03 | 1.03 | 1.03 | 1.03 | 1.03 | 1.03 | 1.03 | 1.03 | 1.03 | 1.03 | 1.03 |
| | -5 | TC | 5.43 | 5.43 | 5.43 | 5.43 | 5.73 | 5.85 | 5.85 | 5.85 | 5.88 | 5.88 | 5.88 | 5.88 | 6.24 | 6.24 | 6.24 | 6.24 | |
| | | S/T | 0.66 | 0.73 | 0.79 | 0.85 | 0.56 | 0.61 | 0.67 | 0.73 | 0.50 | 0.56 | 0.61 | 0.67 | 0.38 | 0.43 | 0.49 | 0.54 | |
| | | PI | 1.03 | 1.02 | 1.02 | 1.03 | 1.03 | 1.03 | 1.03 | 1.03 | 1.03 | 1.03 | 1.03 | 1.03 | 1.03 | 1.03 | 1.03 | 1.03 | 1.03 |
| | 0 | TC | 5.40 | 5.41 | 5.41 | 5.41 | 5.71 | 5.83 | 5.83 | 5.83 | 5.87 | 5.87 | 5.87 | 5.87 | 6.23 | 6.23 | 6.23 | 6.23 | |
| | | S/T | 0.67 | 0.74 | 0.79 | 0.85 | 0.56 | 0.62 | 0.68 | 0.74 | 0.50 | 0.56 | 0.62 | 0.68 | 0.38 | 0.43 | 0.49 | 0.54 | |
| | | PI | 1.03 | 1.03 | 1.03 | 1.03 | 1.03 | 1.03 | 1.03 | 1.03 | 1.03 | 1.03 | 1.03 | 1.03 | 1.03 | 1.03 | 1.03 | 1.03 | 1.03 |
| | 5 | TC | 5.38 | 5.38 | 5.38 | 5.38 | 5.68 | 5.80 | 5.80 | 5.80 | 5.85 | 5.85 | 5.85 | 5.85 | 6.23 | 6.23 | 6.23 | 6.23 | |
| | | S/T | 0.67 | 0.74 | 0.80 | 0.86 | 0.56 | 0.62 | 0.68 | 0.74 | 0.50 | 0.56 | 0.62 | 0.68 | 0.38 | 0.43 | 0.49 | 0.54 | |
| | | PI | 1.04 | 1.04 | 1.04 | 1.04 | 1.04 | 1.04 | 1.04 | 1.04 | 1.04 | 1.04 | 1.04 | 1.04 | 1.04 | 1.04 | 1.04 | 1.04 | 1.04 |
| | 10 | TC | 5.34 | 5.35 | 5.35 | 5.35 | 5.66 | 5.78 | 5.78 | 5.78 | 5.82 | 5.82 | 5.82 | 5.82 | 6.21 | 6.21 | 6.21 | 6.21 | |
| | | S/T | 0.67 | 0.74 | 0.80 | 0.86 | 0.56 | 0.62 | 0.68 | 0.74 | 0.50 | 0.56 | 0.62 | 0.68 | 0.39 | 0.44 | 0.50 | 0.54 | |
| | | PI | 1.06 | 1.05 | 1.05 | 1.06 | 1.06 | 1.06 | 1.06 | 1.06 | 1.06 | 1.06 | 1.06 | 1.06 | 1.05 | 1.05 | 1.05 | 1.05 | |
| | 15 | TC | 5.30 | 5.30 | 5.30 | 5.30 | 5.62 | 5.74 | 5.74 | 5.74 | 5.79 | 5.79 | 5.79 | 5.79 | 6.19 | 6.19 | 6.19 | 6.19 | |
| | | S/T | 0.68 | 0.75 | 0.81 | 0.87 | 0.57 | 0.62 | 0.69 | 0.75 | 0.51 | 0.57 | 0.63 | 0.69 | 0.39 | 0.44 | 0.50 | 0.55 | |
| | | PI | 1.08 | 1.08 | 1.08 | 1.08 | 1.08 | 1.08 | 1.08 | 1.08 | 1.08 | 1.08 | 1.08 | 1.08 | 1.08 | 1.08 | 1.08 | 1.08 | 1.08 |
| | 20 | TC | 5.24 | 5.24 | 5.24 | 5.24 | 5.56 | 5.56 | 5.56 | 5.56 | 5.73 | 5.73 | 5.73 | 5.73 | 6.13 | 6.13 | 6.13 | 6.13 | |
| | | S/T | 0.68 | 0.75 | 0.81 | 0.87 | 0.57 | 0.63 | 0.69 | 0.75 | 0.51 | 0.57 | 0.63 | 0.69 | 0.39 | 0.44 | 0.50 | 0.55 | |
| | | PI | 1.12 | 1.12 | 1.12 | 1.12 | 1.12 | 1.12 | 1.12 | 1.12 | 1.12 | 1.12 | 1.12 | 1.12 | 1.11 | 1.11 | 1.11 | 1.11 | |
| | 25 | TC | 4.99 | 4.99 | 4.99 | 4.99 | 5.30 | 5.30 | 5.30 | 5.30 | 5.47 | 5.47 | 5.47 | 5.47 | 5.87 | 5.87 | 5.87 | 5.87 | |
| | | S/T | 0.69 | 0.75 | 0.82 | 0.89 | 0.57 | 0.63 | 0.69 | 0.76 | 0.51 | 0.57 | 0.64 | 0.70 | 0.39 | 0.44 | 0.50 | 0.56 | |
| | | PI | 1.24 | 1.24 | 1.24 | 1.24 | 1.24 | 1.24 | 1.24 | 1.24 | 1.24 | 1.24 | 1.24 | 1.24 | 1.24 | 1.24 | 1.24 | 1.24 | 1.24 |
| | 30 | TC | 4.76 | 4.76 | 4.76 | 4.81 | 5.07 | 5.07 | 5.07 | 5.07 | 5.22 | 5.22 | 5.22 | 5.22 | 5.62 | 5.62 | 5.62 | 5.62 | |
| | | S/T | 0.69 | 0.76 | 0.83 | 0.90 | 0.57 | 0.63 | 0.70 | 0.77 | 0.51 | 0.58 | 0.64 | 0.70 | 0.38 | 0.44 | 0.50 | 0.56 | |
| | | PI | 1.35 | 1.35 | 1.35 | 1.35 | 1.35 | 1.35 | 1.35 | 1.35 | 1.35 | 1.35 | 1.35 | 1.35 | 1.36 | 1.36 | 1.36 | 1.36 | |
| | 35 | TC | 4.53 | 4.53 | 4.53 | 4.59 | 4.81 | 4.81 | 4.81 | 4.81 | 4.96 | 4.96 | 5.04 | 4.96 | 5.36 | 5.36 | 5.36 | 5.36 | |
| | | S/T | 0.70 | 0.77 | 0.84 | 0.91 | 0.57 | 0.64 | 0.71 | 0.78 | 0.51 | 0.58 | 0.64 | 0.71 | 0.38 | 0.44 | 0.50 | 0.56 | |
| | | PI | 1.48 | 1.48 | 1.48 | 1.48 | 1.48 | 1.48 | 1.48 | 1.48 | 1.49 | 1.49 | 1.49 | 1.49 | 1.50 | 1.50 | 1.50 | 1.50 | |
| | 40 | TC | 4.28 | 4.28 | 4.29 | 4.34 | 4.55 | 4.55 | 4.55 | 4.55 | 4.70 | 4.70 | 4.74 | 4.70 | 5.07 | 5.07 | 5.07 | 5.07 | |
| | | S/T | 0.71 | 0.79 | 0.87 | 0.95 | 0.58 | 0.65 | 0.73 | 0.80 | 0.51 | 0.59 | 0.66 | 0.73 | 0.37 | 0.44 | 0.51 | 0.57 | |
| | | PI | 1.64 | 1.64 | 1.64 | 1.64 | 1.64 | 1.64 | 1.64 | 1.64 | 1.65 | 1.65 | 1.65 | 1.65 | 1.66 | 1.66 | 1.66 | 1.66 | |
| | 46 | TC | 3.97 | 3.97 | 4.00 | 4.02 | 4.22 | 4.22 | 4.22 | 4.22 | 4.37 | 4.37 | 4.37 | 4.37 | 4.71 | 4.71 | 4.71 | 4.71 | |
| | | S/T | 0.72 | 0.80 | 0.88 | 0.96 | 0.58 | 0.66 | 0.74 | 0.82 | 0.51 | 0.59 | 0.67 | 0.74 | 0.37 | 0.44 | 0.51 | 0.58 | |
| | | PI | 1.82 | 1.82 | 1.82 | 1.82 | 1.83 | 1.83 | 1.83 | 1.83 | 1.84 | 1.84 | 1.84 | 1.84 | 1.85 | 1.85 | 1.85 | 1.85 | |
| | 50 | TC | 3.71 | 3.71 | 3.74 | 3.77 | 3.97 | 3.97 | 3.97 | 3.97 | 4.11 | 4.11 | 4.11 | 4.11 | 4.45 | 4.45 | 4.45 | 4.45 | |
| | | S/T | 0.73 | 0.82 | 0.91 | 0.99 | 0.58 | 0.67 | 0.75 | 0.84 | 0.52 | 0.60 | 0.68 | 0.76 | 0.36 | 0.44 | 0.51 | 0.59 | |
| | | PI | 1.98 | 1.98 | 1.98 | 1.98 | 1.98 | 1.98 | 1.98 | 1.98 | 1.99 | 1.99 | 1.99 | 1.99 | 2.01 | 2.01 | 2.01 | 2.01 | |
| | 600 | -15 | TC | 5.62 | 5.62 | 5.62 | 5.68 | 5.90 | 5.90 | 5.90 | 5.90 | 6.06 | 6.06 | 6.06 | 6.06 | 6.43 | 6.43 | 6.43 | 6.43 |
| | | | S/T | 0.68 | 0.74 | 0.98 | 1.00 | 0.55 | 0.62 | 0.69 | 0.75 | 0.49 | 0.56 | 0.63 | 0.70 | 0.36 | 0.42 | 0.48 | 0.55 |
| | | | PI | 1.06 | 1.06 | 1.06 | 1.06 | 1.05 | 1.05 | 1.05 | 1.05 | 1.05 | 1.05 | 1.05 | 1.05 | 1.04 | 1.04 | 1.04 | 1.04 |
| | | -10 | TC | 5.59 | 5.59 | 5.59 | 5.65 | 5.87 | 5.87 | 5.87 | 5.87 | 6.03 | 6.03 | 6.03 | 6.03 | 6.40 | 6.40 | 6.40 | 6.40 |
| | | | S/T | 0.68 | 0.75 | 0.99 | 1.00 | 0.55 | 0.62 | 0.69 | 0.76 | 0.49 | 0.56 | 0.63 | 0.70 | 0.36 | 0.43 | 0.49 | 0.55 |
| | | | PI | 1.05 | 1.05 | 1.05 | 1.05 | 1.05 | 1.05 | 1.05 | 1.05 | 1.05 | 1.05 | 1.05 | 1.05 | 1.05 | 1.05 | 1.05 | 1.05 |
| -5 | | TC | 5.56 | 5.56 | 5.56 | 5.62 | 5.85 | 5.85 | 5.85 | 5.85 | 6.00 | 6.00 | 6.00 | 6.00 | 6.39 | 6.39 | 6.39 | 6.39 | |
| | | S/T | 0.68 | 0.75 | 0.99 | 1.00 | 0.56 | 0.62 | 0.69 | 0.76 | 0.50 | 0.57 | 0.63 | 0.70 | 0.36 | 0.43 | 0.49 | 0.56 | |
| | | PI | 1.05 | 1.05 | 1.05 | 1.05 | 1.05 | 1.05 | 1.05 | 1.05 | 1.05 | 1.05 | 1.05 | 1.05 | 1.05 | 1.05 | 1.05 | 1.05 | |
| 0 | | TC | 5.53 | 5.53 | 5.53 | 5.59 | 5.83 | 5.83 | 5.83 | 5.83 | 5.99 | 5.99 | 5.99 | 5.99 | 6.38 | 6.38 | 6.38 | 6.38 | |
| | | S/T | 0.69 | 0.75 | 1.00 | 1.00 | 0.56 | 0.63 | 0.70 | 0.76 | 0.50 | 0.57 | 0.64 | 0.71 | 0.36 | 0.43 | 0.49 | 0.56 | |
| | | PI | 1.06 | 1.06 | 1.06 | 1.06 | 1.05 | 1.05 | 1.05 | 1.05 | 1.05 | 1.05 | 1.05 | 1.05 | 1.05 | 1.05 | 1.05 | 1.05 | |
| 5 | | TC | 5.50 | 5.50 | 5.50 | 5.56 | 5.80 | 5.80 | 5.80 | 5.80 | 5.97 | 5.97 | 5.97 | 5.97 | 6.38 | 6.38 | 6.38 | 6.38 | |
| | | S/T | 0.69 | 0.76 | 1.00 | 1.00 | 0.56 | 0.63 | 0.70 | 0.77 | 0.50 | 0.57 | 0.64 | 0.71 | 0.36 | 0.43 | 0.49 | 0.56 | |
| | | PI | 1.06 | 1.06 | 1.06 | 1.06 | 1.06 | 1.06 | 1.06 | 1.06 | 1.06 | 1.06 | 1.06 | 1.06 | 1.06 | 1.06 | 1.06 | 1.06 | |
| 10 | | TC | 5.47 | 5.47 | 5.47 | 5.53 | 5.78 | 5.78 | 5.78 | 5.78 | 5.94 | 5.94 | 5.94 | 5.94 | 6.36 | 6.36 | 6.36 | 6.36 | |
| | | S/T | 0.69 | 0.76 | 1.00 | 1.00 | 0.56 | 0.63 | 0.70 | 0.77 | 0.50 | 0.57 | 0.64 | 0.71 | 0.37 | 0.44 | 0.50 | 0.56 | |
| | | PI | 1.08 | 1.08 | 1.08 | 1.08 | 1.08 | 1.08 | 1.08 | 1.08 | 1.08 | 1.08 | 1.08 | 1.08 | 1.07 | 1.07 | 1.07 | 1.07 | |
| 15 | | TC | 5.42 | 5.42 | 5.42 | 5.48 | 5.74 | 5.74 | 5.74 | 5.74 | 5.91 | 5.91 | 5.91 | 5.91 | 6.33 | 6.33 | 6.33 | 6.33 | |
| | | S/T | 0.70 | 0.77 | 0.85 | 0.92 | 0.57 | 0.64 | 0.71 | 0.78 | 0.51 | 0.58 | 0.65 | 0.72 | 0.37 | 0.44 | 0.50 | 0.57 | |
| | | PI | 1.11 | 1.11 | 1.11 | 1.11 | 1.10 | 1.10 | 1.10 | 1.10 | 1.10 | 1.10 | 1.10 | 1.10 | 1.10 | 1.10 | 1.10 | 1.10 | |
| 20 | | TC | 5.36 | 5.36 | 5.36 | 5.42 | 5.68 | 5.68 | 5.68 | 5.68 | 5.85 | 5.85 | 5.85 | 5.85 | 6.28 | 6.28 | 6.28 | 6.28 | |
| | | S/T | 0.70 | 0.77 | 0.85 | 0.92 | 0.57 | 0.64 | 0.71 | 0.78 | 0.51 | 0.58 | 0.65 | 0.72 | 0.37 | 0.44 | 0.50 | 0.57 | |
| | | PI | 1.15 | 1.15 | 1.15 | 1.15 | 1.14 | 1.14 | 1.14 | 1.14 | 1.14 | 1.14 | 1.14 | 1.14 | 1.13 | 1.13 | 1.13 | 1.13 | |
| 25 | | TC | 5.10 | 5.10 | 5.10 | 5.16 | 5.42 | 5.42 | 5.42 | 5.42 | 5.59 | 5.59 | 5.59 | 5.59 | 6.02 | 6.02 | 6.02 | 6.02 | |
| | | S/T | | | | | | | | | | | | | | | | | |

| | | | | | | | | | | | | | | | | | | |
|-----|-----|------|------|------|------|------|------|------|------|------|------|------|------|------|------|------|------|------|
| 800 | -15 | TC | 5.74 | 5.74 | 5.80 | 5.86 | 6.05 | 6.05 | 6.05 | 6.05 | 6.20 | 6.20 | 6.20 | 6.20 | 6.57 | 6.57 | 6.57 | 6.57 |
| | | S/T | 0.72 | 0.81 | 1.00 | 1.00 | 0.57 | 0.66 | 0.74 | 0.98 | 0.50 | 0.59 | 0.68 | 0.76 | 0.34 | 0.42 | 0.50 | 0.58 |
| | | PI | 1.08 | 1.08 | 1.08 | 1.08 | 1.07 | 1.07 | 1.07 | 1.07 | 1.07 | 1.07 | 1.07 | 1.07 | 1.07 | 1.07 | 1.07 | 1.07 |
| | -10 | TC | 5.71 | 5.71 | 5.77 | 5.83 | 6.02 | 6.02 | 6.02 | 6.02 | 6.17 | 6.17 | 6.17 | 6.17 | 6.55 | 6.55 | 6.55 | 6.55 |
| | | S/T | 0.73 | 0.82 | 1.00 | 1.00 | 0.57 | 0.66 | 0.75 | 0.98 | 0.50 | 0.59 | 0.68 | 0.77 | 0.34 | 0.43 | 0.50 | 0.58 |
| | | PI | 1.07 | 1.07 | 1.07 | 1.07 | 1.07 | 1.07 | 1.07 | 1.07 | 1.07 | 1.07 | 1.07 | 1.07 | 1.07 | 1.07 | 1.07 | 1.07 |
| | -5 | TC | 5.67 | 5.67 | 5.73 | 5.79 | 6.00 | 6.00 | 6.00 | 6.00 | 6.15 | 6.15 | 6.15 | 6.15 | 6.53 | 6.53 | 6.53 | 6.53 |
| | | S/T | 0.73 | 0.82 | 1.00 | 1.00 | 0.58 | 0.66 | 0.75 | 0.99 | 0.51 | 0.59 | 0.68 | 0.77 | 0.34 | 0.43 | 0.51 | 0.59 |
| | | PI | 1.07 | 1.07 | 1.07 | 1.07 | 1.06 | 1.06 | 1.06 | 1.06 | 1.07 | 1.07 | 1.07 | 1.07 | 1.07 | 1.07 | 1.07 | 1.07 |
| | 0 | TC | 5.65 | 5.65 | 5.71 | 5.76 | 5.97 | 5.97 | 5.97 | 5.97 | 6.13 | 6.13 | 6.13 | 6.13 | 6.53 | 6.53 | 6.53 | 6.53 |
| | | S/T | 0.74 | 0.82 | 1.00 | 1.00 | 0.58 | 0.67 | 0.75 | 0.99 | 0.51 | 0.60 | 0.69 | 0.77 | 0.34 | 0.43 | 0.51 | 0.59 |
| | | PI | 1.07 | 1.07 | 1.07 | 1.07 | 1.07 | 1.07 | 1.07 | 1.07 | 1.07 | 1.07 | 1.07 | 1.07 | 1.08 | 1.08 | 1.08 | 1.08 |
| | 5 | TC | 5.62 | 5.62 | 5.68 | 5.74 | 5.95 | 5.95 | 5.95 | 5.95 | 6.11 | 6.11 | 6.11 | 6.11 | 6.52 | 6.52 | 6.52 | 6.52 |
| | | S/T | 0.74 | 0.83 | 1.00 | 1.00 | 0.58 | 0.67 | 0.76 | 1.00 | 0.51 | 0.60 | 0.69 | 0.78 | 0.34 | 0.43 | 0.51 | 0.59 |
| | | PI | 1.08 | 1.08 | 1.08 | 1.08 | 1.08 | 1.08 | 1.08 | 1.08 | 1.08 | 1.08 | 1.08 | 1.08 | 1.09 | 1.09 | 1.09 | 1.09 |
| | 10 | TC | 5.58 | 5.58 | 5.64 | 5.70 | 5.92 | 5.92 | 5.92 | 5.92 | 6.09 | 6.09 | 6.09 | 6.09 | 6.51 | 6.51 | 6.51 | 6.51 |
| | | S/T | 0.74 | 0.83 | 1.00 | 1.00 | 0.58 | 0.67 | 0.76 | 1.00 | 0.51 | 0.60 | 0.69 | 0.78 | 0.35 | 0.44 | 0.51 | 0.59 |
| | | PI | 1.10 | 1.10 | 1.10 | 1.10 | 1.09 | 1.09 | 1.09 | 1.09 | 1.10 | 1.10 | 1.10 | 1.10 | 1.10 | 1.10 | 1.10 | 1.10 |
| 15 | TC | 5.54 | 5.54 | 5.60 | 5.65 | 5.88 | 5.88 | 5.88 | 5.88 | 6.05 | 6.05 | 6.05 | 6.05 | 6.48 | 6.48 | 6.48 | 6.48 | |
| | S/T | 0.75 | 0.84 | 0.94 | 1.00 | 0.59 | 0.68 | 0.77 | 0.87 | 0.52 | 0.61 | 0.70 | 0.79 | 0.35 | 0.44 | 0.52 | 0.60 | |
| | PI | 1.13 | 1.13 | 1.13 | 1.13 | 1.12 | 1.12 | 1.12 | 1.12 | 1.12 | 1.12 | 1.12 | 1.12 | 1.12 | 1.12 | 1.12 | 1.12 | |
| 20 | TC | 5.48 | 5.48 | 5.53 | 5.59 | 5.82 | 5.82 | 5.82 | 5.82 | 5.99 | 5.99 | 5.99 | 5.99 | 6.42 | 6.42 | 6.42 | 6.42 | |
| | S/T | 0.75 | 0.84 | 0.94 | 1.00 | 0.59 | 0.68 | 0.77 | 0.87 | 0.52 | 0.61 | 0.70 | 0.79 | 0.35 | 0.44 | 0.52 | 0.60 | |
| | PI | 1.17 | 1.17 | 1.17 | 1.17 | 1.16 | 1.16 | 1.16 | 1.16 | 1.16 | 1.16 | 1.16 | 1.16 | 1.16 | 1.16 | 1.16 | 1.16 | |
| 25 | TC | 5.22 | 5.22 | 5.28 | 5.33 | 5.56 | 5.56 | 5.56 | 5.56 | 5.73 | 5.73 | 5.73 | 5.73 | 6.16 | 6.16 | 6.16 | 6.16 | |
| | S/T | 0.76 | 0.86 | 0.96 | 1.00 | 0.60 | 0.69 | 0.79 | 0.88 | 0.52 | 0.61 | 0.71 | 0.80 | 0.35 | 0.44 | 0.52 | 0.61 | |
| | PI | 1.29 | 1.29 | 1.29 | 1.29 | 1.29 | 1.29 | 1.29 | 1.29 | 1.29 | 1.29 | 1.29 | 1.29 | 1.29 | 1.29 | 1.29 | 1.29 | |
| 30 | TC | 4.99 | 4.99 | 5.05 | 5.10 | 5.30 | 5.30 | 5.30 | 5.36 | 5.45 | 5.45 | 5.45 | 5.45 | 5.88 | 5.88 | 5.88 | 5.88 | |
| | S/T | 0.77 | 0.88 | 0.98 | 1.00 | 0.60 | 0.70 | 0.80 | 0.90 | 0.52 | 0.62 | 0.72 | 0.82 | 0.35 | 0.44 | 0.53 | 0.62 | |
| | PI | 1.40 | 1.40 | 1.40 | 1.40 | 1.41 | 1.41 | 1.41 | 1.41 | 1.41 | 1.41 | 1.41 | 1.41 | 1.42 | 1.42 | 1.42 | 1.42 | |
| 35 | TC | 4.73 | 4.79 | 4.85 | 4.90 | 5.05 | 5.05 | 5.05 | 5.10 | 5.19 | 5.19 | 5.19 | 5.19 | 5.59 | 5.59 | 5.59 | 5.59 | |
| | S/T | 0.78 | 0.89 | 1.00 | 1.00 | 0.61 | 0.71 | 0.82 | 0.92 | 0.53 | 0.63 | 0.73 | 0.84 | 0.34 | 0.44 | 0.54 | 0.63 | |
| | PI | 1.54 | 1.54 | 1.54 | 1.54 | 1.54 | 1.54 | 1.54 | 1.54 | 1.55 | 1.55 | 1.55 | 1.55 | 1.56 | 1.56 | 1.56 | 1.56 | |
| 40 | TC | 4.39 | 4.43 | 4.47 | 4.52 | 4.68 | 4.68 | 4.68 | 4.74 | 4.82 | 4.82 | 4.87 | 4.85 | 5.21 | 5.21 | 5.21 | 5.21 | |
| | S/T | 0.81 | 0.93 | 1.00 | 1.00 | 0.62 | 0.74 | 0.86 | 0.97 | 0.54 | 0.65 | 0.76 | 0.88 | 0.34 | 0.44 | 0.55 | 0.90 | |
| | PI | 1.70 | 1.70 | 1.70 | 1.70 | 1.70 | 1.70 | 1.70 | 1.70 | 1.71 | 1.71 | 1.71 | 1.71 | 1.72 | 1.72 | 1.72 | 1.72 | |
| 46 | TC | 4.06 | 4.09 | 4.12 | 4.15 | 4.35 | 4.35 | 4.35 | 4.40 | 4.49 | 4.49 | 4.49 | 4.54 | 4.85 | 4.85 | 4.85 | 4.85 | |
| | S/T | 0.82 | 0.95 | 1.00 | 1.00 | 0.63 | 0.75 | 0.87 | 0.99 | 0.54 | 0.66 | 0.78 | 0.89 | 0.34 | 0.44 | 0.55 | 0.92 | |
| | PI | 1.89 | 1.89 | 1.89 | 1.89 | 1.89 | 1.89 | 1.89 | 1.89 | 1.90 | 1.90 | 1.90 | 1.90 | 1.92 | 1.92 | 1.92 | 1.92 | |
| 50 | TC | 3.81 | 3.84 | 3.87 | 3.89 | 4.06 | 4.06 | 4.06 | 4.12 | 4.20 | 4.20 | 4.20 | 4.23 | 4.57 | 4.57 | 4.57 | 4.57 | |
| | S/T | 0.85 | 0.98 | 1.00 | 1.00 | 0.64 | 0.77 | 0.90 | 1.00 | 0.55 | 0.67 | 0.80 | 0.92 | 0.33 | 0.45 | 0.56 | 0.97 | |
| | PI | 2.05 | 2.05 | 2.05 | 2.05 | 2.05 | 2.05 | 2.05 | 2.05 | 2.06 | 2.06 | 2.06 | 2.06 | 2.08 | 2.08 | 2.08 | 2.08 | |

TC:Total Cooling Capacity (kW)

S/T:Sensible Cooling Capacity Ratio

PI:Power Input(kW)

Note: The table shows the case where the operation frequency of a compressor is fixed.

| 42QH024D8S+38QH024D8S | | | | | | | | | | | | | | | | | | | |
|-----------------------|---------------|-----------|-----------|------|------|------|------|------|------|------|------|------|------|------|------|------|------|------|------|
| INDOOR AIRFLOW (CMH) | OUTDOOR DB(C) | ID WB (C) | 16.0 | | | | 18.0 | | | | 19.0 | | | | 22.0 | | | | |
| | | | ID DB (C) | 23.0 | 25.0 | 27.0 | 30.0 | 23.0 | 25.0 | 27.0 | 30.0 | 23.0 | 25.0 | 27.0 | 30.0 | 23.0 | 25.0 | 27.0 | 30.0 |
| 610 | -15 | TC | 7.35 | 7.34 | 7.34 | 7.34 | 7.73 | 7.88 | 7.88 | 7.88 | 7.93 | 7.93 | 7.93 | 7.93 | 8.40 | 8.40 | 8.40 | 8.40 | |
| | | S/T | 0.66 | 0.70 | 0.76 | 0.82 | 0.55 | 0.60 | 0.66 | 0.70 | 0.50 | 0.55 | 0.61 | 0.66 | 0.39 | 0.43 | 0.48 | 0.53 | |
| | | PI | 1.61 | 1.61 | 1.61 | 1.61 | 1.61 | 1.61 | 1.61 | 1.61 | 1.60 | 1.60 | 1.60 | 1.60 | 1.60 | 1.60 | 1.60 | 1.60 | 1.60 |
| | -10 | TC | 7.31 | 7.30 | 7.30 | 7.30 | 7.69 | 7.84 | 7.84 | 7.84 | 7.89 | 7.89 | 7.89 | 7.89 | 8.37 | 8.37 | 8.37 | 8.37 | |
| | | S/T | 0.66 | 0.71 | 0.77 | 0.82 | 0.55 | 0.61 | 0.66 | 0.71 | 0.50 | 0.55 | 0.61 | 0.66 | 0.39 | 0.44 | 0.49 | 0.53 | |
| | | PI | 1.60 | 1.60 | 1.60 | 1.60 | 1.60 | 1.60 | 1.60 | 1.60 | 1.60 | 1.60 | 1.60 | 1.60 | 1.60 | 1.60 | 1.60 | 1.60 | 1.60 |
| | -5 | TC | 7.26 | 7.26 | 7.26 | 7.26 | 7.66 | 7.81 | 7.81 | 7.81 | 7.86 | 7.86 | 7.86 | 7.86 | 8.35 | 8.35 | 8.35 | 8.35 | |
| | | S/T | 0.66 | 0.71 | 0.77 | 0.83 | 0.56 | 0.61 | 0.66 | 0.71 | 0.51 | 0.56 | 0.61 | 0.66 | 0.39 | 0.44 | 0.49 | 0.54 | |
| | | PI | 1.60 | 1.60 | 1.60 | 1.60 | 1.60 | 1.60 | 1.60 | 1.60 | 1.60 | 1.60 | 1.60 | 1.60 | 1.60 | 1.60 | 1.60 | 1.60 | 1.60 |
| | 0 | TC | 7.23 | 7.22 | 7.22 | 7.22 | 7.63 | 7.78 | 7.78 | 7.78 | 7.84 | 7.84 | 7.84 | 7.84 | 8.34 | 8.34 | 8.34 | 8.34 | |
| | | S/T | 0.67 | 0.72 | 0.77 | 0.83 | 0.56 | 0.61 | 0.67 | 0.72 | 0.51 | 0.56 | 0.62 | 0.67 | 0.39 | 0.44 | 0.49 | 0.54 | |
| | | PI | 1.61 | 1.60 | 1.60 | 1.61 | 1.61 | 1.61 | 1.61 | 1.61 | 1.60 | 1.60 | 1.60 | 1.60 | 1.61 | 1.61 | 1.61 | 1.61 | 1.61 |
| | 5 | TC | 7.19 | 7.18 | 7.18 | 7.18 | 7.60 | 7.75 | 7.75 | 7.75 | 7.82 | 7.82 | 7.82 | 7.82 | 8.34 | 8.34 | 8.34 | 8.34 | |
| | | S/T | 0.67 | 0.72 | 0.78 | 0.84 | 0.56 | 0.61 | 0.67 | 0.72 | 0.51 | 0.56 | 0.62 | 0.67 | 0.39 | 0.44 | 0.49 | 0.54 | |
| | | PI | 1.62 | 1.62 | 1.62 | 1.62 | 1.62 | 1.62 | 1.62 | 1.62 | 1.62 | 1.62 | 1.62 | 1.62 | 1.62 | 1.62 | 1.62 | 1.62 | 1.62 |
| | 10 | TC | 7.15 | 7.14 | 7.14 | 7.14 | 7.56 | 7.71 | 7.71 | 7.71 | 7.79 | 7.79 | 7.79 | 7.79 | 8.31 | 8.31 | 8.31 | 8.31 | |
| | | S/T | 0.67 | 0.72 | 0.78 | 0.84 | 0.56 | 0.62 | 0.67 | 0.72 | 0.51 | 0.56 | 0.62 | 0.67 | 0.40 | 0.45 | 0.50 | 0.54 | |
| | | PI | 1.65 | 1.64 | 1.64 | 1.65 | 1.65 | 1.65 | 1.65 | 1.65 | 1.64 | 1.64 | 1.64 | 1.64 | 1.64 | 1.64 | 1.64 | 1.64 | 1.64 |
| | 15 | TC | 7.09 | 7.08 | 7.08 | 7.08 | 7.51 | 7.66 | 7.66 | 7.66 | 7.74 | 7.74 | 7.74 | 7.74 | 8.28 | 8.28 | 8.28 | 8.28 | |
| | | S/T | 0.68 | 0.73 | 0.79 | 0.85 | 0.57 | 0.62 | 0.68 | 0.73 | 0.52 | 0.57 | 0.63 | 0.68 | 0.40 | 0.45 | 0.50 | 0.55 | |
| | | PI | 1.69 | 1.68 | 1.68 | 1.69 | 1.69 | 1.69 | 1.69 | 1.69 | 1.68 | 1.68 | 1.68 | 1.68 | 1.67 | 1.67 | 1.67 | 1.67 | |
| | 20 | TC | 7.01 | 7.00 | 7.00 | 7.00 | 7.43 | 7.43 | 7.43 | 7.43 | 7.66 | 7.66 | 7.66 | 7.66 | 8.21 | 8.21 | 8.21 | 8.21 | |
| | | S/T | 0.68 | 0.73 | 0.79 | 0.85 | 0.57 | 0.62 | 0.68 | 0.73 | 0.52 | 0.57 | 0.63 | 0.68 | 0.40 | 0.45 | 0.50 | 0.55 | |
| | | PI | 1.75 | 1.74 | 1.74 | 1.75 | 1.74 | 1.74 | 1.74 | 1.74 | 1.73 | 1.73 | 1.73 | 1.73 | 1.72 | 1.72 | 1.72 | 1.72 | |
| | 25 | TC | 6.69 | 6.69 | 6.69 | 6.69 | 7.09 | 7.09 | 7.09 | 7.09 | 7.32 | 7.32 | 7.32 | 7.32 | 7.86 | 7.86 | 7.86 | 7.86 | |
| | | S/T | 0.68 | 0.74 | 0.80 | 0.86 | 0.57 | 0.63 | 0.68 | 0.74 | 0.52 | 0.57 | 0.63 | 0.68 | 0.40 | 0.45 | 0.50 | 0.55 | |
| | | PI | 1.93 | 1.93 | 1.93 | 1.93 | 1.92 | 1.92 | 1.92 | 1.92 | 1.92 | 1.92 | 1.92 | 1.92 | 1.93 | 1.93 | 1.93 | 1.93 | |
| | 30 | TC | 6.37 | 6.37 | 6.37 | 6.37 | 6.77 | 6.77 | 6.77 | 6.77 | 6.97 | 6.97 | 6.97 | 6.97 | 7.52 | 7.52 | 7.52 | 7.52 | |
| | | S/T | 0.68 | 0.75 | 0.81 | 0.87 | 0.57 | 0.63 | 0.69 | 0.75 | 0.51 | 0.57 | 0.63 | 0.69 | 0.39 | 0.45 | 0.50 | 0.55 | |
| | | PI | 2.11 | 2.11 | 2.11 | 2.11 | 2.12 | 2.12 | 2.12 | 2.12 | 2.12 | 2.12 | 2.12 | 2.12 | 2.13 | 2.13 | 2.13 | 2.13 | |
| | 35 | TC | 6.06 | 6.06 | 6.06 | 6.11 | 6.43 | 6.43 | 6.43 | 6.43 | 6.63 | 6.63 | 6.63 | 6.63 | 7.17 | 7.17 | 7.17 | 7.17 | |
| | | S/T | 0.69 | 0.75 | 0.82 | 0.89 | 0.57 | 0.63 | 0.70 | 0.76 | 0.51 | 0.57 | 0.63 | 0.70 | 0.39 | 0.44 | 0.50 | 0.56 | |
| | | PI | 2.30 | 2.30 | 2.30 | 2.30 | 2.31 | 2.31 | 2.31 | 2.31 | 2.32 | 2.32 | 2.32 | 2.32 | 2.33 | 2.33 | 2.33 | 2.33 | |
| | 40 | TC | 5.71 | 5.71 | 5.71 | 5.77 | 6.07 | 6.07 | 6.07 | 6.07 | 6.27 | 6.27 | 6.27 | 6.27 | 6.78 | 6.78 | 6.78 | 6.78 | |
| | | S/T | 0.70 | 0.77 | 0.84 | 0.92 | 0.57 | 0.64 | 0.71 | 0.78 | 0.51 | 0.58 | 0.65 | 0.71 | 0.38 | 0.44 | 0.50 | 0.56 | |
| | | PI | 2.54 | 2.54 | 2.54 | 2.54 | 2.55 | 2.55 | 2.55 | 2.55 | 2.56 | 2.56 | 2.56 | 2.56 | 2.58 | 2.58 | 2.58 | 2.58 | |
| | 46 | TC | 5.29 | 5.29 | 5.29 | 5.35 | 5.63 | 5.63 | 5.63 | 5.63 | 5.83 | 5.83 | 5.83 | 5.83 | 6.29 | 6.29 | 6.29 | 6.29 | |
| | | S/T | 0.70 | 0.78 | 0.86 | 0.93 | 0.57 | 0.65 | 0.72 | 0.79 | 0.51 | 0.58 | 0.65 | 0.72 | 0.37 | 0.44 | 0.50 | 0.57 | |
| | | PI | 2.83 | 2.83 | 2.83 | 2.83 | 2.84 | 2.84 | 2.84 | 2.84 | 2.85 | 2.85 | 2.85 | 2.85 | 2.87 | 2.87 | 2.87 | 2.87 | |
| | 50 | TC | 4.94 | 4.94 | 4.94 | 5.00 | 5.29 | 5.29 | 5.29 | 5.29 | 5.49 | 5.49 | 5.49 | 5.49 | 5.95 | 5.95 | 5.95 | 5.95 | |
| | | S/T | 0.71 | 0.80 | 0.88 | 0.96 | 0.58 | 0.65 | 0.73 | 0.81 | 0.51 | 0.59 | 0.66 | 0.74 | 0.37 | 0.44 | 0.51 | 0.57 | |
| | | PI | 3.07 | 3.07 | 3.07 | 3.07 | 3.08 | 3.08 | 3.08 | 3.08 | 3.09 | 3.09 | 3.09 | 3.09 | 3.11 | 3.11 | 3.11 | 3.11 | |
| | 770 | -15 | TC | 7.50 | 7.50 | 7.50 | 7.56 | 7.88 | 7.88 | 7.88 | 7.88 | 8.09 | 8.09 | 8.09 | 8.09 | 8.58 | 8.58 | 8.58 | 8.58 |
| | | | S/T | 0.67 | 0.74 | 0.98 | 1.00 | 0.55 | 0.62 | 0.69 | 0.74 | 0.49 | 0.56 | 0.62 | 0.69 | 0.37 | 0.42 | 0.48 | 0.54 |
| | | | PI | 1.64 | 1.64 | 1.64 | 1.64 | 1.64 | 1.64 | 1.64 | 1.64 | 1.64 | 1.64 | 1.64 | 1.64 | 1.63 | 1.63 | 1.63 | 1.63 |
| | | -10 | TC | 7.45 | 7.45 | 7.45 | 7.51 | 7.84 | 7.84 | 7.84 | 7.84 | 8.05 | 8.05 | 8.05 | 8.05 | 8.55 | 8.55 | 8.55 | 8.55 |
| | | | S/T | 0.67 | 0.75 | 0.99 | 1.00 | 0.55 | 0.62 | 0.69 | 0.75 | 0.49 | 0.56 | 0.62 | 0.69 | 0.37 | 0.43 | 0.49 | 0.54 |
| | | | PI | 1.63 | 1.63 | 1.63 | 1.63 | 1.63 | 1.63 | 1.63 | 1.63 | 1.63 | 1.63 | 1.63 | 1.63 | 1.64 | 1.64 | 1.64 | 1.64 |
| -5 | | TC | 7.41 | 7.41 | 7.41 | 7.47 | 7.81 | 7.81 | 7.81 | 7.81 | 8.02 | 8.02 | 8.02 | 8.02 | 8.53 | 8.53 | 8.53 | 8.53 | |
| | | S/T | 0.67 | 0.75 | 0.99 | 1.00 | 0.56 | 0.62 | 0.69 | 0.75 | 0.50 | 0.57 | 0.62 | 0.69 | 0.37 | 0.43 | 0.49 | 0.55 | |
| | | PI | 1.63 | 1.63 | 1.63 | 1.63 | 1.63 | 1.63 | 1.63 | 1.63 | 1.63 | 1.63 | 1.63 | 1.63 | 1.64 | 1.64 | 1.64 | 1.64 | |
| 0 | | TC | 7.37 | 7.37 | 7.37 | 7.43 | 7.78 | 7.78 | 7.78 | 7.78 | 7.99 | 7.99 | 7.99 | 7.99 | 8.52 | 8.52 | 8.52 | 8.52 | |
| | | S/T | 0.68 | 0.75 | 1.00 | 1.00 | 0.56 | 0.63 | 0.70 | 0.75 | 0.50 | 0.57 | 0.63 | 0.70 | 0.37 | 0.43 | 0.49 | 0.55 | |
| | | PI | 1.64 | 1.64 | 1.64 | 1.64 | 1.64 | 1.64 | 1.64 | 1.64 | 1.64 | 1.64 | 1.64 | 1.64 | 1.64 | 1.64 | 1.64 | 1.64 | |
| 5 | | TC | 7.33 | 7.33 | 7.33 | 7.39 | 7.75 | 7.75 | 7.75 | 7.75 | 7.97 | 7.97 | 7.97 | 7.97 | 8.51 | 8.51 | 8.51 | 8.51 | |
| | | S/T | 0.68 | 0.76 | 1.00 | 1.00 | 0.56 | 0.63 | 0.70 | 0.76 | 0.50 | 0.57 | 0.63 | 0.70 | 0.37 | 0.43 | 0.49 | 0.55 | |
| | | PI | 1.65 | 1.65 | 1.65 | 1.65 | 1.65 | 1.65 | 1.65 | 1.65 | 1.65 | 1.65 | 1.65 | 1.65 | 1.65 | 1.65 | 1.65 | 1.65 | |
| 10 | | TC | 7.29 | 7.29 | 7.29 | 7.35 | 7.71 | 7.71 | 7.71 | 7.71 | 7.93 | 7.93 | 7.93 | 7.93 | 8.49 | 8.49 | 8.49 | 8.49 | |
| | | S/T | 0.68 | 0.76 | 1.00 | 1.00 | 0.56 | 0.63 | 0.70 | 0.76 | 0.50 | 0.57 | 0.63 | 0.70 | 0.38 | 0.44 | 0.50 | 0.55 | |
| | | PI | 1.68 | 1.68 | 1.68 | 1.68 | 1.68 | 1.68 | 1.68 | 1.68 | 1.68 | 1.68 | 1.68 | 1.68 | 1.68 | 1.68 | 1.68 | 1.68 | |
| 15 | | TC | 7.23 | 7.23 | 7.23 | 7.29 | 7.66 | 7.66 | 7.66 | 7.66 | 7.89 | 7.89 | 7.89 | 7.89 | 8.46 | 8.46 | 8.46 | 8.46 | |
| | | S/T | 0.69 | 0.77 | 0.84 | 0.91 | 0.57 | 0.64 | 0.71 | 0.77 | 0.51 | 0.58 | 0.64 | 0.71 | 0.38 | 0.44 | 0.50 | 0.56 | |
| | | PI | 1.72 | 1.72 | 1.72 | 1.72 | 1.72 | 1.72 | 1.72 | 1.72 | 1.72 | 1.72 | 1.72 | 1.72 | 1.71 | 1.71 | 1.71 | 1.71 | |
| 20 | | TC | 7.15 | 7.15 | 7.15 | 7.21 | 7.58 | 7.58 | 7.58 | 7.58 | 7.81 | 7.81 | 7.81 | 7.81 | 8.38 | 8.38 | 8.38 | 8.38 | |
| | | S/T | 0.69 | 0.77 | 0.84 | 0.91 | 0.57 | 0.64 | 0.71 | 0.77 | 0.51 | 0.58 | 0.64 | 0.71 | 0.38 | 0.44 | 0.50 | 0.56 | |
| | | PI | 1.78 | 1.78 | 1.78 | 1.78 | 1.77 | 1.77 | 1.77 | 1.77 | 1.77 | 1.77 | 1.77 | 1.77 | 1.76 | 1.76 | 1.76 | 1.76 | |
| 25 | | TC | 6.83 | 6.83 | 6.83 | 6.89 | 7.26 | 7.26 | 7.26 | 7.26 | 7.46 | 7.46 | 7.46 | 7.46 | 8.04 | 8.04 | 8.04 | 8.04 | |
| | | S/T | 0.70 | 0.77 | | | | | | | | | | | | | | | |

| | | | | | | | | | | | | | | | | | | |
|------|-----|------|------|------|------|------|------|------|------|------|------|------|------|------|------|------|------|------|
| 1090 | -15 | TC | 7.68 | 7.68 | 7.77 | 7.86 | 8.06 | 8.06 | 8.06 | 8.06 | 8.26 | 8.26 | 8.26 | 8.26 | 8.79 | 8.79 | 8.79 | 8.79 |
| | | S/T | 0.72 | 0.82 | 1.00 | 1.00 | 0.57 | 0.67 | 0.75 | 0.98 | 0.50 | 0.59 | 0.68 | 0.76 | 0.34 | 0.42 | 0.50 | 0.59 |
| | | PI | 1.68 | 1.68 | 1.68 | 1.68 | 1.67 | 1.67 | 1.67 | 1.67 | 1.67 | 1.67 | 1.67 | 1.67 | 1.67 | 1.67 | 1.67 | 1.67 |
| | -10 | TC | 7.63 | 7.63 | 7.72 | 7.81 | 8.02 | 8.02 | 8.02 | 8.02 | 8.22 | 8.22 | 8.22 | 8.22 | 8.76 | 8.76 | 8.76 | 8.76 |
| | | S/T | 0.73 | 0.82 | 1.00 | 1.00 | 0.57 | 0.67 | 0.76 | 0.98 | 0.50 | 0.59 | 0.68 | 0.77 | 0.34 | 0.43 | 0.50 | 0.59 |
| | | PI | 1.67 | 1.67 | 1.67 | 1.67 | 1.67 | 1.67 | 1.67 | 1.67 | 1.67 | 1.67 | 1.67 | 1.67 | 1.67 | 1.67 | 1.67 | 1.67 |
| | -5 | TC | 7.59 | 7.59 | 7.68 | 7.77 | 7.99 | 7.99 | 7.99 | 7.99 | 8.19 | 8.19 | 8.19 | 8.19 | 8.73 | 8.73 | 8.73 | 8.73 |
| | | S/T | 0.73 | 0.83 | 1.00 | 1.00 | 0.58 | 0.67 | 0.76 | 0.99 | 0.51 | 0.59 | 0.68 | 0.77 | 0.34 | 0.43 | 0.51 | 0.59 |
| | | PI | 1.67 | 1.67 | 1.67 | 1.67 | 1.67 | 1.67 | 1.67 | 1.67 | 1.67 | 1.67 | 1.67 | 1.67 | 1.67 | 1.67 | 1.67 | 1.67 |
| | 0 | TC | 7.55 | 7.55 | 7.64 | 7.73 | 7.96 | 7.96 | 7.96 | 7.96 | 8.17 | 8.17 | 8.17 | 8.17 | 8.73 | 8.73 | 8.73 | 8.73 |
| | | S/T | 0.74 | 0.83 | 1.00 | 1.00 | 0.58 | 0.68 | 0.76 | 0.99 | 0.51 | 0.60 | 0.69 | 0.77 | 0.34 | 0.43 | 0.51 | 0.60 |
| | | PI | 1.68 | 1.68 | 1.68 | 1.68 | 1.67 | 1.67 | 1.67 | 1.67 | 1.68 | 1.68 | 1.68 | 1.68 | 1.68 | 1.68 | 1.68 | 1.68 |
| | 5 | TC | 7.51 | 7.51 | 7.60 | 7.69 | 7.93 | 7.93 | 7.93 | 7.93 | 8.14 | 8.14 | 8.14 | 8.14 | 8.72 | 8.72 | 8.72 | 8.72 |
| | | S/T | 0.74 | 0.84 | 1.00 | 1.00 | 0.58 | 0.68 | 0.77 | 1.00 | 0.51 | 0.60 | 0.69 | 0.78 | 0.34 | 0.43 | 0.51 | 0.60 |
| | | PI | 1.69 | 1.69 | 1.69 | 1.69 | 1.69 | 1.69 | 1.69 | 1.69 | 1.69 | 1.69 | 1.69 | 1.69 | 1.69 | 1.69 | 1.69 | 1.69 |
| | 10 | TC | 7.47 | 7.47 | 7.55 | 7.64 | 7.89 | 7.89 | 7.89 | 7.89 | 8.11 | 8.11 | 8.11 | 8.11 | 8.70 | 8.70 | 8.70 | 8.70 |
| | | S/T | 0.74 | 0.84 | 1.00 | 1.00 | 0.58 | 0.68 | 0.77 | 1.00 | 0.51 | 0.60 | 0.69 | 0.78 | 0.35 | 0.44 | 0.51 | 0.60 |
| | | PI | 1.72 | 1.72 | 1.72 | 1.72 | 1.71 | 1.71 | 1.71 | 1.71 | 1.72 | 1.72 | 1.72 | 1.72 | 1.71 | 1.71 | 1.71 | 1.71 |
| 15 | TC | 7.40 | 7.40 | 7.49 | 7.58 | 7.83 | 7.83 | 7.83 | 7.83 | 8.06 | 8.06 | 8.06 | 8.06 | 8.66 | 8.66 | 8.66 | 8.66 | |
| | S/T | 0.75 | 0.85 | 0.94 | 1.00 | 0.59 | 0.69 | 0.78 | 0.88 | 0.52 | 0.61 | 0.70 | 0.79 | 0.35 | 0.44 | 0.52 | 0.61 | |
| | PI | 1.76 | 1.76 | 1.76 | 1.76 | 1.75 | 1.75 | 1.75 | 1.75 | 1.75 | 1.75 | 1.75 | 1.75 | 1.75 | 1.75 | 1.75 | 1.75 | |
| 20 | TC | 7.32 | 7.32 | 7.41 | 7.49 | 7.75 | 7.75 | 7.75 | 7.75 | 7.98 | 7.98 | 7.98 | 7.98 | 8.58 | 8.58 | 8.58 | 8.58 | |
| | S/T | 0.75 | 0.85 | 0.94 | 1.00 | 0.59 | 0.69 | 0.78 | 0.88 | 0.52 | 0.61 | 0.70 | 0.79 | 0.35 | 0.44 | 0.52 | 0.61 | |
| | PI | 1.82 | 1.82 | 1.82 | 1.82 | 1.81 | 1.81 | 1.81 | 1.81 | 1.81 | 1.81 | 1.81 | 1.81 | 1.80 | 1.80 | 1.80 | 1.80 | |
| 25 | TC | 6.98 | 6.98 | 7.03 | 7.09 | 7.41 | 7.41 | 7.41 | 7.49 | 7.64 | 7.64 | 7.64 | 7.64 | 8.21 | 8.21 | 8.21 | 8.21 | |
| | S/T | 0.76 | 0.87 | 0.97 | 1.00 | 0.60 | 0.70 | 0.80 | 0.89 | 0.52 | 0.62 | 0.71 | 0.81 | 0.35 | 0.44 | 0.53 | 0.62 | |
| | PI | 2.01 | 2.01 | 2.01 | 2.01 | 2.01 | 2.01 | 2.01 | 2.01 | 2.01 | 2.01 | 2.01 | 2.01 | 2.01 | 2.01 | 2.01 | 2.01 | |
| 30 | TC | 6.63 | 6.63 | 6.69 | 6.75 | 7.06 | 7.06 | 7.06 | 7.12 | 7.29 | 7.29 | 7.29 | 7.29 | 7.84 | 7.84 | 7.84 | 7.84 | |
| | S/T | 0.77 | 0.88 | 0.99 | 1.00 | 0.60 | 0.71 | 0.81 | 0.91 | 0.53 | 0.63 | 0.73 | 0.83 | 0.35 | 0.44 | 0.53 | 0.63 | |
| | PI | 2.19 | 2.19 | 2.19 | 2.19 | 2.20 | 2.20 | 2.20 | 2.20 | 2.20 | 2.20 | 2.20 | 2.20 | 2.21 | 2.21 | 2.21 | 2.21 | |
| 35 | TC | 6.32 | 6.37 | 6.43 | 6.49 | 6.72 | 6.72 | 6.72 | 6.78 | 6.92 | 6.92 | 7.03 | 6.92 | 7.46 | 7.46 | 7.46 | 7.46 | |
| | S/T | 0.79 | 0.90 | 1.00 | 1.00 | 0.61 | 0.72 | 0.83 | 0.93 | 0.53 | 0.64 | 0.74 | 0.85 | 0.34 | 0.44 | 0.54 | 0.64 | |
| | PI | 2.40 | 2.40 | 2.40 | 2.40 | 2.41 | 2.41 | 2.41 | 2.41 | 2.42 | 2.42 | 2.42 | 2.42 | 2.43 | 2.43 | 2.43 | 2.43 | |
| 40 | TC | 5.90 | 5.96 | 6.02 | 6.07 | 6.29 | 6.29 | 6.29 | 6.35 | 6.48 | 6.48 | 6.54 | 6.50 | 7.00 | 7.00 | 7.00 | 7.00 | |
| | S/T | 0.82 | 0.94 | 1.00 | 1.00 | 0.63 | 0.75 | 0.87 | 0.98 | 0.54 | 0.65 | 0.77 | 0.88 | 0.34 | 0.44 | 0.55 | 0.90 | |
| | PI | 2.65 | 2.65 | 2.65 | 2.65 | 2.66 | 2.66 | 2.66 | 2.66 | 2.67 | 2.67 | 2.67 | 2.67 | 2.69 | 2.69 | 2.69 | 2.69 | |
| 46 | TC | 5.47 | 5.53 | 5.58 | 5.64 | 5.84 | 5.84 | 5.84 | 5.90 | 6.01 | 6.01 | 6.01 | 6.07 | 6.52 | 6.52 | 6.52 | 6.52 | |
| | S/T | 0.83 | 0.96 | 1.00 | 1.00 | 0.63 | 0.76 | 0.88 | 1.00 | 0.54 | 0.66 | 0.78 | 0.90 | 0.33 | 0.45 | 0.56 | 0.92 | |
| | PI | 2.95 | 2.95 | 2.95 | 2.95 | 2.96 | 2.96 | 2.96 | 2.96 | 2.97 | 2.97 | 2.97 | 2.97 | 3.00 | 3.00 | 3.00 | 3.00 | |
| 50 | TC | 5.13 | 5.18 | 5.24 | 5.30 | 5.47 | 5.47 | 5.53 | 5.58 | 5.67 | 5.67 | 5.67 | 5.73 | 6.12 | 6.12 | 6.12 | 6.12 | |
| | S/T | 0.86 | 0.99 | 1.00 | 1.00 | 0.65 | 0.78 | 0.91 | 1.00 | 0.55 | 0.68 | 0.81 | 0.93 | 0.33 | 0.45 | 0.57 | 0.97 | |
| | PI | 3.20 | 3.20 | 3.20 | 3.20 | 3.21 | 3.21 | 3.21 | 3.21 | 3.22 | 3.22 | 3.22 | 3.22 | 3.24 | 3.24 | 3.24 | 3.24 | |

TC:Total Cooling Capacity (kW)

S/T:Sensible Cooling Capacity Ratio

PI:Power Input(kW)

Note: The table shows the case where the operation frequency of a compressor is fixed.

6.2 Heating

| 42QH009D8S+38QH009D8S | | | | | | | | [SI_Unit] | |
|-----------------------|--|-------------------------------------|------|------|------|----------------------------------|------|-----------|------|
| INDOOR AIRFLOW (CMH) | HEATING PERFORMANCE AT INDOOR DRY BULB TEMPERATURE | | | | | | | | |
| | OUTDOOR DB(°C) | TC:TOTAL CAPACITY IN KILOWATTS (KW) | | | | PI:TOTAL POWER IN KILOWATTS (KW) | | | |
| | | Indoor Conditions (DB °C) | | | | Indoor Conditions (DB °C) | | | |
| | | 16.0 | 20.0 | 22.0 | 24.0 | 16.0 | 20.0 | 22.0 | 24.0 |
| 260 | -15.0 | 2.34 | 2.32 | 2.29 | 2.29 | 0.98 | 1.02 | 0.99 | 0.99 |
| | -10.0 | 2.50 | 2.47 | 2.44 | 2.44 | 1.05 | 1.09 | 1.06 | 1.06 |
| | -7.0 | 2.62 | 2.59 | 2.56 | 2.56 | 1.11 | 1.15 | 1.12 | 1.12 |
| | -5.6 | 2.62 | 2.59 | 2.56 | 2.56 | 1.07 | 1.08 | 1.08 | 1.08 |
| | -2.8 | 2.59 | 2.56 | 2.56 | 2.53 | 1.01 | 1.01 | 1.01 | 1.01 |
| | 0.0 | 2.56 | 2.53 | 2.50 | 2.50 | 0.94 | 0.94 | 0.94 | 0.94 |
| | 2.8 | 2.62 | 2.56 | 2.56 | 2.53 | 0.88 | 0.88 | 0.87 | 0.87 |
| | 5.6 | 2.74 | 2.71 | 2.68 | 2.68 | 0.83 | 0.82 | 0.82 | 0.82 |
| | 7.0 | 2.87 | 2.84 | 2.81 | 2.79 | 0.79 | 0.75 | 0.78 | 0.78 |
| | 11.1 | 2.93 | 2.90 | 2.87 | 2.84 | 0.70 | 0.69 | 0.68 | 0.67 |
| | 13.9 | 2.99 | 2.93 | 2.93 | 2.90 | 0.64 | 0.62 | 0.61 | 0.61 |
| 16.7 | 3.05 | 2.99 | 2.96 | 2.93 | 0.57 | 0.56 | 0.55 | 0.54 | |
| 18.0 | 3.05 | 3.02 | 2.99 | 2.96 | 0.54 | 0.52 | 0.51 | 0.50 | |
| 330 | -15.0 | 2.38 | 2.35 | 2.35 | 2.32 | 0.99 | 1.03 | 1.00 | 1.01 |
| | -10.0 | 2.54 | 2.51 | 2.51 | 2.48 | 1.06 | 1.10 | 1.07 | 1.08 |
| | -7.0 | 2.66 | 2.63 | 2.63 | 2.60 | 1.12 | 1.17 | 1.13 | 1.14 |
| | -5.6 | 2.65 | 2.62 | 2.62 | 2.59 | 1.09 | 1.09 | 1.09 | 1.10 |
| | -2.8 | 2.65 | 2.62 | 2.59 | 2.59 | 1.02 | 1.02 | 1.02 | 1.02 |
| | 0.0 | 2.62 | 2.56 | 2.56 | 2.53 | 0.95 | 0.95 | 0.95 | 0.95 |
| | 2.8 | 2.65 | 2.62 | 2.62 | 2.59 | 0.89 | 0.89 | 0.89 | 0.88 |
| | 5.6 | 2.79 | 2.76 | 2.74 | 2.74 | 0.84 | 0.84 | 0.83 | 0.83 |
| | 7.0 | 2.93 | 2.90 | 2.87 | 2.84 | 0.80 | 0.76 | 0.79 | 0.79 |
| | 11.1 | 2.99 | 2.96 | 2.93 | 2.93 | 0.71 | 0.70 | 0.69 | 0.69 |
| | 13.9 | 3.05 | 3.02 | 2.99 | 2.96 | 0.65 | 0.63 | 0.62 | 0.62 |
| 16.7 | 3.10 | 3.05 | 3.02 | 3.02 | 0.58 | 0.57 | 0.56 | 0.55 | |
| 18.0 | 3.13 | 3.08 | 3.05 | 3.02 | 0.55 | 0.53 | 0.52 | 0.51 | |
| 460 | -15.0 | 2.39 | 2.37 | 2.34 | 2.34 | 1.00 | 1.04 | 1.01 | 1.01 |
| | -10.0 | 2.56 | 2.53 | 2.50 | 2.50 | 1.07 | 1.10 | 1.08 | 1.08 |
| | -7.0 | 2.68 | 2.65 | 2.62 | 2.62 | 1.13 | 1.17 | 1.14 | 1.14 |
| | -5.6 | 2.68 | 2.65 | 2.62 | 2.62 | 1.09 | 1.10 | 1.10 | 1.10 |
| | -2.8 | 2.68 | 2.65 | 2.62 | 2.62 | 1.03 | 1.03 | 1.03 | 1.03 |
| | 0.0 | 2.62 | 2.59 | 2.59 | 2.56 | 0.96 | 0.96 | 0.96 | 0.96 |
| | 2.8 | 2.68 | 2.65 | 2.62 | 2.62 | 0.90 | 0.90 | 0.89 | 0.89 |
| | 5.6 | 2.82 | 2.79 | 2.76 | 2.74 | 0.84 | 0.84 | 0.84 | 0.84 |
| | 7.0 | 2.96 | 2.93 | 2.90 | 2.87 | 0.81 | 0.77 | 0.80 | 0.80 |
| | 11.1 | 3.02 | 2.99 | 2.96 | 2.96 | 0.72 | 0.71 | 0.70 | 0.69 |
| | 13.9 | 3.08 | 3.05 | 3.02 | 2.99 | 0.66 | 0.64 | 0.63 | 0.63 |
| 16.7 | 3.13 | 3.08 | 3.08 | 3.05 | 0.59 | 0.57 | 0.57 | 0.56 | |
| 18.0 | 3.16 | 3.10 | 3.08 | 3.08 | 0.56 | 0.54 | 0.53 | 0.52 | |

Note: The table shows the case where the operation frequency of a compressor is fixed.

| 42QHG009D8SH+38QHG009D8SH | | | | | | | | [SI_Unit] | |
|---------------------------|--|-------------------------------------|------|------|------|----------------------------------|------|-----------|------|
| INDOOR AIRFLOW (CMH) | HEATING PERFORMANCE AT INDOOR DRY BULB TEMPERATURE | | | | | | | | |
| | OUTDOOR DB(°C) | TC:TOTAL CAPACITY IN KILOWATTS (KW) | | | | PI:TOTAL POWER IN KILOWATTS (KW) | | | |
| | | Indoor Conditions (DB °C) | | | | Indoor Conditions (DB °C) | | | |
| | | 16.0 | 20.0 | 22.0 | 24.0 | 16.0 | 20.0 | 22.0 | 24.0 |
| 300 | -15.0 | 2.29 | 2.26 | 2.26 | 2.23 | 0.93 | 0.97 | 0.94 | 0.94 |
| | -10.0 | 2.44 | 2.41 | 2.41 | 2.39 | 1.00 | 1.03 | 1.00 | 1.00 |
| | -7.0 | 2.56 | 2.53 | 2.53 | 2.50 | 1.06 | 1.10 | 1.07 | 1.07 |
| | -5.6 | 2.56 | 2.53 | 2.53 | 2.50 | 1.02 | 1.02 | 1.02 | 1.02 |
| | -2.8 | 2.56 | 2.53 | 2.53 | 2.50 | 0.95 | 0.95 | 0.95 | 0.95 |
| | 0.0 | 2.53 | 2.50 | 2.47 | 2.47 | 0.88 | 0.87 | 0.87 | 0.87 |
| | 2.8 | 2.59 | 2.56 | 2.53 | 2.53 | 0.81 | 0.80 | 0.80 | 0.79 |
| | 5.6 | 2.73 | 2.70 | 2.67 | 2.64 | 0.74 | 0.73 | 0.73 | 0.72 |
| | 7.0 | 2.87 | 2.84 | 2.81 | 2.79 | 0.71 | 0.66 | 0.69 | 0.69 |
| | 11.1 | 2.96 | 2.90 | 2.90 | 2.87 | 0.61 | 0.59 | 0.58 | 0.57 |
| | 13.9 | 3.02 | 2.96 | 2.93 | 2.93 | 0.55 | 0.53 | 0.52 | 0.51 |
| | 16.7 | 3.08 | 3.02 | 2.99 | 2.96 | 0.48 | 0.46 | 0.44 | 0.43 |
| 18.0 | 3.08 | 3.05 | 3.02 | 2.99 | 0.45 | 0.42 | 0.41 | 0.40 | |
| 360 | -15.0 | 2.34 | 2.32 | 2.32 | 2.29 | 0.94 | 0.97 | 0.94 | 0.94 |
| | -10.0 | 2.50 | 2.47 | 2.47 | 2.45 | 1.00 | 1.04 | 1.00 | 1.00 |
| | -7.0 | 2.62 | 2.59 | 2.59 | 2.56 | 1.07 | 1.10 | 1.07 | 1.07 |
| | -5.6 | 2.62 | 2.59 | 2.59 | 2.56 | 1.03 | 1.03 | 1.03 | 1.03 |
| | -2.8 | 2.62 | 2.59 | 2.59 | 2.56 | 0.95 | 0.95 | 0.95 | 0.95 |
| | 0.0 | 2.59 | 2.56 | 2.53 | 2.53 | 0.88 | 0.88 | 0.87 | 0.87 |
| | 2.8 | 2.64 | 2.62 | 2.59 | 2.59 | 0.82 | 0.81 | 0.80 | 0.80 |
| | 5.6 | 2.79 | 2.76 | 2.73 | 2.70 | 0.75 | 0.74 | 0.73 | 0.73 |
| | 7.0 | 2.93 | 2.90 | 2.87 | 2.84 | 0.72 | 0.67 | 0.70 | 0.69 |
| | 11.1 | 3.02 | 2.96 | 2.93 | 2.93 | 0.61 | 0.60 | 0.59 | 0.58 |
| | 13.9 | 3.08 | 3.02 | 2.99 | 2.99 | 0.55 | 0.53 | 0.52 | 0.51 |
| | 16.7 | 3.10 | 3.08 | 3.05 | 3.02 | 0.48 | 0.46 | 0.45 | 0.44 |
| 18.0 | 3.13 | 3.10 | 3.08 | 3.05 | 0.45 | 0.42 | 0.41 | 0.40 | |
| 510 | -15.0 | 2.36 | 2.34 | 2.34 | 2.31 | 0.95 | 0.99 | 0.95 | 0.96 |
| | -10.0 | 2.52 | 2.50 | 2.50 | 2.47 | 1.01 | 1.05 | 1.01 | 1.02 |
| | -7.0 | 2.64 | 2.62 | 2.62 | 2.59 | 1.08 | 1.12 | 1.08 | 1.09 |
| | -5.6 | 2.64 | 2.62 | 2.62 | 2.59 | 1.04 | 1.04 | 1.04 | 1.04 |
| | -2.8 | 2.64 | 2.62 | 2.59 | 2.59 | 0.97 | 0.96 | 0.96 | 0.96 |
| | 0.0 | 2.62 | 2.59 | 2.56 | 2.56 | 0.89 | 0.89 | 0.88 | 0.88 |
| | 2.8 | 2.67 | 2.64 | 2.62 | 2.59 | 0.82 | 0.82 | 0.81 | 0.81 |
| | 5.6 | 2.82 | 2.76 | 2.76 | 2.73 | 0.76 | 0.74 | 0.74 | 0.73 |
| | 7.0 | 2.99 | 2.93 | 2.90 | 2.87 | 0.72 | 0.67 | 0.70 | 0.70 |
| | 11.1 | 3.05 | 2.99 | 2.99 | 2.96 | 0.62 | 0.60 | 0.59 | 0.58 |
| | 13.9 | 3.10 | 3.05 | 3.02 | 3.02 | 0.56 | 0.54 | 0.53 | 0.51 |
| | 16.7 | 3.16 | 3.10 | 3.08 | 3.05 | 0.49 | 0.46 | 0.45 | 0.44 |
| 18.0 | 3.19 | 3.13 | 3.10 | 3.08 | 0.45 | 0.43 | 0.41 | 0.40 | |

Note: The table shows the case where the operation frequency of a compressor is fixed.

| 42QHG012D8S+38QHG018D8S | | | | | | | | [SI_Unit] | |
|-------------------------|--|-------------------------------------|------|------|------|----------------------------------|------|-----------|------|
| INDOOR AIRFLOW (CMH) | HEATING PERFORMANCE AT INDOOR DRY BULB TEMPERATURE | | | | | | | | |
| | OUTDOOR DB(°C) | TC:TOTAL CAPACITY IN KILOWATTS (KW) | | | | PI:TOTAL POWER IN KILOWATTS (KW) | | | |
| | | Indoor Conditions (DB °C) | | | | Indoor Conditions (DB °C) | | | |
| | | 16.0 | 20.0 | 22.0 | 24.0 | 16.0 | 20.0 | 22.0 | 24.0 |
| 350 | -15.0 | 2.35 | 2.33 | 2.30 | 2.30 | 0.92 | 0.95 | 0.95 | 0.96 |
| | -10.0 | 2.51 | 2.49 | 2.46 | 2.46 | 0.99 | 1.01 | 1.01 | 1.02 |
| | -7.0 | 2.63 | 2.60 | 2.58 | 2.58 | 1.05 | 1.08 | 1.08 | 1.09 |
| | -5.6 | 2.75 | 2.72 | 2.69 | 2.69 | 1.04 | 1.06 | 1.07 | 1.08 |
| | -2.8 | 2.87 | 2.84 | 2.81 | 2.78 | 1.02 | 1.04 | 1.05 | 1.06 |
| | 0.0 | 2.92 | 2.89 | 2.87 | 2.87 | 1.00 | 1.02 | 1.03 | 1.04 |
| | 2.8 | 3.13 | 3.07 | 3.04 | 3.04 | 1.00 | 1.02 | 1.03 | 1.04 |
| | 5.6 | 3.42 | 3.36 | 3.33 | 3.33 | 0.99 | 1.01 | 1.02 | 1.03 |
| | 7.0 | 3.76 | 3.69 | 3.61 | 3.58 | 0.99 | 1.01 | 1.02 | 1.03 |
| | 11.1 | 3.93 | 3.90 | 3.87 | 3.84 | 0.97 | 0.99 | 1.00 | 1.01 |
| | 13.9 | 4.13 | 4.07 | 4.04 | 4.01 | 0.96 | 0.98 | 0.99 | 1.00 |
| | 16.7 | 4.30 | 4.25 | 4.22 | 4.19 | 0.95 | 0.97 | 0.98 | 0.99 |
| 18.0 | 4.39 | 4.33 | 4.30 | 4.28 | 0.95 | 0.96 | 0.97 | 0.98 | |
| 400 | -15.0 | 2.40 | 2.38 | 2.35 | 2.35 | 0.92 | 0.96 | 0.96 | 0.97 |
| | -10.0 | 2.56 | 2.54 | 2.51 | 2.51 | 0.99 | 1.02 | 1.02 | 1.03 |
| | -7.0 | 2.69 | 2.66 | 2.63 | 2.63 | 1.05 | 1.09 | 1.09 | 1.10 |
| | -5.6 | 2.81 | 2.78 | 2.75 | 2.75 | 1.04 | 1.06 | 1.08 | 1.09 |
| | -2.8 | 2.92 | 2.89 | 2.87 | 2.84 | 1.03 | 1.05 | 1.06 | 1.07 |
| | 0.0 | 3.01 | 2.95 | 2.95 | 2.92 | 1.01 | 1.03 | 1.04 | 1.05 |
| | 2.8 | 3.18 | 3.15 | 3.13 | 3.10 | 1.00 | 1.02 | 1.03 | 1.05 |
| | 5.6 | 3.47 | 3.44 | 3.42 | 3.39 | 1.00 | 1.02 | 1.03 | 1.04 |
| | 7.0 | 3.81 | 3.78 | 3.69 | 3.66 | 1.00 | 1.01 | 1.03 | 1.04 |
| | 11.1 | 4.04 | 3.98 | 3.96 | 3.93 | 0.98 | 1.00 | 1.01 | 1.02 |
| | 13.9 | 4.22 | 4.16 | 4.13 | 4.10 | 0.97 | 0.99 | 1.00 | 1.01 |
| | 16.7 | 4.42 | 4.36 | 4.33 | 4.30 | 0.96 | 0.98 | 0.99 | 0.99 |
| 18.0 | 4.51 | 4.45 | 4.42 | 4.39 | 0.95 | 0.97 | 0.98 | 0.99 | |
| 530 | -15.0 | 2.43 | 2.41 | 2.38 | 2.38 | 0.94 | 0.97 | 0.97 | 0.98 |
| | -10.0 | 2.60 | 2.57 | 2.54 | 2.54 | 1.01 | 1.03 | 1.03 | 1.04 |
| | -7.0 | 2.72 | 2.69 | 2.66 | 2.66 | 1.07 | 1.10 | 1.10 | 1.11 |
| | -5.6 | 2.84 | 2.81 | 2.78 | 2.78 | 1.05 | 1.08 | 1.09 | 1.10 |
| | -2.8 | 2.95 | 2.92 | 2.89 | 2.89 | 1.04 | 1.06 | 1.07 | 1.08 |
| | 0.0 | 3.04 | 2.98 | 2.98 | 2.95 | 1.02 | 1.04 | 1.05 | 1.06 |
| | 2.8 | 3.21 | 3.18 | 3.15 | 3.13 | 1.02 | 1.04 | 1.05 | 1.06 |
| | 5.6 | 3.50 | 3.47 | 3.44 | 3.42 | 1.01 | 1.03 | 1.04 | 1.05 |
| | 7.0 | 3.84 | 3.81 | 3.72 | 3.69 | 1.01 | 1.03 | 1.04 | 1.05 |
| | 11.1 | 4.07 | 4.01 | 3.98 | 3.96 | 0.99 | 1.01 | 1.02 | 1.03 |
| | 13.9 | 4.25 | 4.19 | 4.16 | 4.13 | 0.98 | 1.00 | 1.01 | 1.02 |
| | 16.7 | 4.45 | 4.39 | 4.36 | 4.30 | 0.97 | 0.99 | 1.00 | 1.01 |
| 18.0 | 4.54 | 4.48 | 4.45 | 4.39 | 0.97 | 0.98 | 0.99 | 1.00 | |

Note: The table shows the case where the operation frequency of a compressor is fixed.

| 42QHG012D8SH+38QHG012D8SH | | | | | | | | [SI_Unit] | |
|---------------------------|--|-------------------------------------|------|------|------|----------------------------------|------|-----------|------|
| INDOOR AIRFLOW (CMH) | HEATING PERFORMANCE AT INDOOR DRY BULB TEMPERATURE | | | | | | | | |
| | OUTDOOR DB(°C) | TC:TOTAL CAPACITY IN KILOWATTS (KW) | | | | PI:TOTAL POWER IN KILOWATTS (KW) | | | |
| | | Indoor Conditions (DB °C) | | | | Indoor Conditions (DB °C) | | | |
| | | 16.0 | 20.0 | 22.0 | 24.0 | 16.0 | 20.0 | 22.0 | 24.0 |
| 310 | -15.0 | 2.37 | 2.34 | 2.32 | 2.32 | 0.93 | 0.95 | 0.95 | 0.95 |
| | -10.0 | 2.53 | 2.50 | 2.48 | 2.48 | 0.99 | 1.02 | 1.01 | 1.02 |
| | -7.0 | 2.65 | 2.62 | 2.59 | 2.59 | 1.05 | 1.08 | 1.07 | 1.08 |
| | -5.6 | 2.77 | 2.74 | 2.71 | 2.71 | 1.03 | 1.05 | 1.06 | 1.07 |
| | -2.8 | 2.88 | 2.86 | 2.83 | 2.80 | 1.00 | 1.02 | 1.03 | 1.04 |
| | 0.0 | 2.94 | 2.91 | 2.88 | 2.88 | 0.98 | 1.00 | 1.00 | 1.01 |
| | 2.8 | 3.15 | 3.09 | 3.06 | 3.06 | 0.96 | 0.98 | 0.99 | 1.00 |
| | 5.6 | 3.44 | 3.38 | 3.35 | 3.35 | 0.95 | 0.96 | 0.97 | 0.98 |
| | 7.0 | 3.76 | 3.69 | 3.61 | 3.58 | 0.94 | 0.95 | 0.96 | 0.97 |
| | 11.1 | 3.93 | 3.90 | 3.87 | 3.84 | 0.91 | 0.92 | 0.93 | 0.94 |
| | 13.9 | 4.13 | 4.07 | 4.04 | 4.01 | 0.89 | 0.90 | 0.91 | 0.92 |
| | 16.7 | 4.30 | 4.25 | 4.22 | 4.19 | 0.87 | 0.88 | 0.89 | 0.89 |
| 18.0 | 4.39 | 4.33 | 4.30 | 4.28 | 0.86 | 0.87 | 0.88 | 0.88 | |
| 370 | -15.0 | 2.41 | 2.38 | 2.36 | 2.33 | 0.94 | 0.97 | 0.96 | 0.97 |
| | -10.0 | 2.57 | 2.54 | 2.52 | 2.49 | 1.00 | 1.03 | 1.03 | 1.04 |
| | -7.0 | 2.69 | 2.67 | 2.64 | 2.61 | 1.06 | 1.09 | 1.09 | 1.10 |
| | -5.6 | 2.83 | 2.80 | 2.77 | 2.74 | 1.04 | 1.06 | 1.07 | 1.08 |
| | -2.8 | 2.94 | 2.88 | 2.88 | 2.86 | 1.02 | 1.03 | 1.04 | 1.05 |
| | 0.0 | 3.00 | 2.97 | 2.94 | 2.94 | 0.99 | 1.01 | 1.01 | 1.02 |
| | 2.8 | 3.21 | 3.15 | 3.15 | 3.12 | 0.97 | 0.99 | 1.00 | 1.01 |
| | 5.6 | 3.50 | 3.47 | 3.44 | 3.41 | 0.96 | 0.97 | 0.98 | 0.99 |
| | 7.0 | 3.81 | 3.78 | 3.69 | 3.66 | 0.95 | 0.96 | 0.97 | 0.98 |
| | 11.1 | 4.04 | 3.98 | 3.96 | 3.93 | 0.92 | 0.93 | 0.94 | 0.95 |
| | 13.9 | 4.22 | 4.16 | 4.13 | 4.10 | 0.90 | 0.91 | 0.92 | 0.92 |
| | 16.7 | 4.42 | 4.36 | 4.33 | 4.30 | 0.88 | 0.89 | 0.89 | 0.90 |
| 18.0 | 4.51 | 4.45 | 4.42 | 4.39 | 0.87 | 0.88 | 0.88 | 0.89 | |
| 520 | -15.0 | 2.42 | 2.40 | 2.40 | 2.37 | 0.94 | 0.97 | 0.96 | 0.97 |
| | -10.0 | 2.59 | 2.56 | 2.56 | 2.53 | 1.00 | 1.04 | 1.03 | 1.04 |
| | -7.0 | 2.71 | 2.68 | 2.68 | 2.65 | 1.06 | 1.10 | 1.09 | 1.10 |
| | -5.6 | 2.83 | 2.80 | 2.80 | 2.77 | 1.05 | 1.07 | 1.08 | 1.09 |
| | -2.8 | 2.94 | 2.91 | 2.88 | 2.88 | 1.02 | 1.04 | 1.05 | 1.06 |
| | 0.0 | 3.03 | 3.00 | 2.97 | 2.94 | 1.00 | 1.02 | 1.02 | 1.03 |
| | 2.8 | 3.23 | 3.18 | 3.15 | 3.15 | 0.98 | 1.00 | 1.01 | 1.02 |
| | 5.6 | 3.53 | 3.50 | 3.47 | 3.44 | 0.97 | 0.98 | 0.99 | 1.00 |
| | 7.0 | 3.84 | 3.81 | 3.72 | 3.69 | 0.96 | 0.97 | 0.98 | 0.99 |
| | 11.1 | 4.07 | 4.01 | 3.98 | 3.96 | 0.93 | 0.94 | 0.95 | 0.96 |
| | 13.9 | 4.28 | 4.22 | 4.19 | 4.16 | 0.91 | 0.92 | 0.93 | 0.94 |
| | 16.7 | 4.45 | 4.39 | 4.36 | 4.33 | 0.89 | 0.90 | 0.91 | 0.91 |
| 18.0 | 4.54 | 4.48 | 4.45 | 4.42 | 0.88 | 0.89 | 0.90 | 0.90 | |

Note: The table shows the case where the operation frequency of a compressor is fixed.

| 42QHG018D8S+38QHG018D8S | | | | | | | | [SI_Unit] | |
|-------------------------|--|-------------------------------------|------|------|------|----------------------------------|------|-----------|------|
| INDOOR AIRFLOW (CMH) | HEATING PERFORMANCE AT INDOOR DRY BULB TEMPERATURE | | | | | | | | |
| | OUTDOOR DB(°C) | TC:TOTAL CAPACITY IN KILOWATTS (KW) | | | | PI:TOTAL POWER IN KILOWATTS (KW) | | | |
| | | Indoor Conditions (DB °C) | | | | Indoor Conditions (DB °C) | | | |
| | | 16.0 | 20.0 | 22.0 | 24.0 | 16.0 | 20.0 | 22.0 | 24.0 |
| 500 | -15.0 | 4.08 | 4.05 | 4.03 | 4.00 | 1.62 | 1.67 | 1.65 | 1.67 |
| | -10.0 | 4.36 | 4.33 | 4.30 | 4.27 | 1.72 | 1.78 | 1.76 | 1.78 |
| | -7.0 | 4.56 | 4.53 | 4.51 | 4.48 | 1.83 | 1.89 | 1.87 | 1.89 |
| | -5.6 | 4.62 | 4.59 | 4.56 | 4.53 | 1.80 | 1.82 | 1.84 | 1.85 |
| | -2.8 | 4.68 | 4.62 | 4.59 | 4.56 | 1.74 | 1.77 | 1.78 | 1.79 |
| | 0.0 | 4.65 | 4.62 | 4.59 | 4.56 | 1.68 | 1.71 | 1.72 | 1.73 |
| | 2.8 | 4.83 | 4.77 | 4.74 | 4.68 | 1.65 | 1.67 | 1.68 | 1.69 |
| | 5.6 | 5.12 | 5.06 | 5.03 | 5.00 | 1.61 | 1.63 | 1.64 | 1.65 |
| | 7.0 | 5.46 | 5.39 | 5.31 | 5.28 | 1.59 | 1.59 | 1.62 | 1.63 |
| | 11.1 | 5.63 | 5.57 | 5.51 | 5.48 | 1.52 | 1.54 | 1.54 | 1.55 |
| | 13.9 | 5.80 | 5.71 | 5.66 | 5.63 | 1.47 | 1.49 | 1.49 | 1.50 |
| | 16.7 | 5.95 | 5.86 | 5.80 | 5.77 | 1.43 | 1.44 | 1.44 | 1.45 |
| 18.0 | 6.00 | 5.92 | 5.89 | 5.83 | 1.40 | 1.41 | 1.42 | 1.42 | |
| 600 | -15.0 | 4.20 | 4.15 | 4.15 | 4.12 | 1.63 | 1.69 | 1.67 | 1.69 |
| | -10.0 | 4.49 | 4.43 | 4.43 | 4.40 | 1.74 | 1.80 | 1.78 | 1.80 |
| | -7.0 | 4.70 | 4.64 | 4.64 | 4.61 | 1.85 | 1.91 | 1.89 | 1.91 |
| | -5.6 | 4.74 | 4.68 | 4.68 | 4.65 | 1.82 | 1.84 | 1.86 | 1.87 |
| | -2.8 | 4.80 | 4.74 | 4.71 | 4.68 | 1.76 | 1.79 | 1.80 | 1.81 |
| | 0.0 | 4.77 | 4.71 | 4.68 | 4.65 | 1.70 | 1.73 | 1.74 | 1.75 |
| | 2.8 | 4.91 | 4.85 | 4.83 | 4.80 | 1.67 | 1.69 | 1.70 | 1.71 |
| | 5.6 | 5.23 | 5.17 | 5.15 | 5.12 | 1.63 | 1.65 | 1.66 | 1.67 |
| | 7.0 | 5.57 | 5.51 | 5.42 | 5.39 | 1.61 | 1.61 | 1.64 | 1.65 |
| | 11.1 | 5.74 | 5.68 | 5.63 | 5.60 | 1.54 | 1.56 | 1.56 | 1.57 |
| | 13.9 | 5.92 | 5.83 | 5.77 | 5.74 | 1.49 | 1.51 | 1.51 | 1.52 |
| | 16.7 | 6.06 | 5.97 | 5.92 | 5.89 | 1.44 | 1.46 | 1.46 | 1.47 |
| 18.0 | 6.15 | 6.03 | 6.00 | 5.95 | 1.42 | 1.43 | 1.44 | 1.44 | |
| 800 | -15.0 | 4.21 | 4.18 | 4.16 | 4.13 | 1.65 | 1.70 | 1.69 | 1.70 |
| | -10.0 | 4.49 | 4.47 | 4.44 | 4.41 | 1.76 | 1.82 | 1.80 | 1.82 |
| | -7.0 | 4.71 | 4.68 | 4.65 | 4.62 | 1.87 | 1.93 | 1.91 | 1.93 |
| | -5.6 | 4.77 | 4.74 | 4.71 | 4.68 | 1.83 | 1.86 | 1.88 | 1.89 |
| | -2.8 | 4.83 | 4.77 | 4.74 | 4.71 | 1.78 | 1.81 | 1.82 | 1.83 |
| | 0.0 | 4.83 | 4.77 | 4.74 | 4.71 | 1.72 | 1.75 | 1.76 | 1.77 |
| | 2.8 | 4.97 | 4.91 | 4.88 | 4.85 | 1.68 | 1.71 | 1.72 | 1.73 |
| | 5.6 | 5.29 | 5.23 | 5.20 | 5.15 | 1.65 | 1.67 | 1.68 | 1.69 |
| | 7.0 | 5.63 | 5.57 | 5.48 | 5.45 | 1.63 | 1.63 | 1.66 | 1.67 |
| | 11.1 | 5.83 | 5.74 | 5.71 | 5.66 | 1.56 | 1.58 | 1.58 | 1.59 |
| | 13.9 | 5.97 | 5.89 | 5.86 | 5.80 | 1.51 | 1.53 | 1.53 | 1.54 |
| | 16.7 | 6.12 | 6.03 | 6.00 | 5.95 | 1.46 | 1.48 | 1.48 | 1.49 |
| 18.0 | 6.21 | 6.12 | 6.06 | 6.03 | 1.44 | 1.45 | 1.46 | 1.46 | |

Note: The table shows the case where the operation frequency of a compressor is fixed.

| 42QHG024D8S+38QHG024D8S | | | | | | | | [SI_Unit] | |
|-------------------------|--|-------------------------------------|------|------|------|----------------------------------|------|-----------|------|
| INDOOR AIRFLOW (CMH) | HEATING PERFORMANCE AT INDOOR DRY BULB TEMPERATURE | | | | | | | | |
| | OUTDOOR DB(°C) | TC:TOTAL CAPACITY IN KILOWATTS (KW) | | | | PI:TOTAL POWER IN KILOWATTS (KW) | | | |
| | | Indoor Conditions (DB °C) | | | | Indoor Conditions (DB °C) | | | |
| | | 16.0 | 20.0 | 22.0 | 24.0 | 16.0 | 20.0 | 22.0 | 24.0 |
| 610 | -15.0 | 5.39 | 5.34 | 5.31 | 5.29 | 2.26 | 2.34 | 2.30 | 2.32 |
| | -10.0 | 5.76 | 5.70 | 5.67 | 5.65 | 2.41 | 2.50 | 2.46 | 2.48 |
| | -7.0 | 6.03 | 5.97 | 5.94 | 5.91 | 2.56 | 2.65 | 2.61 | 2.63 |
| | -5.6 | 6.09 | 6.03 | 6.00 | 5.97 | 2.50 | 2.54 | 2.55 | 2.57 |
| | -2.8 | 6.15 | 6.09 | 6.06 | 6.03 | 2.40 | 2.43 | 2.45 | 2.46 |
| | 0.0 | 6.15 | 6.06 | 6.03 | 5.97 | 2.31 | 2.34 | 2.34 | 2.35 |
| | 2.8 | 6.32 | 6.26 | 6.20 | 6.17 | 2.23 | 2.25 | 2.26 | 2.27 |
| | 5.6 | 6.75 | 6.67 | 6.61 | 6.58 | 2.16 | 2.17 | 2.18 | 2.19 |
| | 7.0 | 7.19 | 7.10 | 6.98 | 6.95 | 2.12 | 2.09 | 2.14 | 2.14 |
| | 11.1 | 7.41 | 7.30 | 7.27 | 7.21 | 1.99 | 1.99 | 2.00 | 2.00 |
| | 13.9 | 7.62 | 7.50 | 7.44 | 7.39 | 1.90 | 1.90 | 1.90 | 1.90 |
| | 16.7 | 7.82 | 7.70 | 7.65 | 7.59 | 1.81 | 1.81 | 1.80 | 1.80 |
| 18.0 | 7.91 | 7.79 | 7.73 | 7.67 | 1.76 | 1.76 | 1.76 | 1.76 | |
| 770 | -15.0 | 5.49 | 5.43 | 5.41 | 5.38 | 2.29 | 2.37 | 2.33 | 2.35 |
| | -10.0 | 5.86 | 5.80 | 5.78 | 5.75 | 2.44 | 2.52 | 2.49 | 2.50 |
| | -7.0 | 6.14 | 6.08 | 6.05 | 6.02 | 2.59 | 2.68 | 2.64 | 2.66 |
| | -5.6 | 6.20 | 6.15 | 6.12 | 6.09 | 2.53 | 2.56 | 2.58 | 2.60 |
| | -2.8 | 6.26 | 6.20 | 6.17 | 6.12 | 2.43 | 2.46 | 2.47 | 2.49 |
| | 0.0 | 6.26 | 6.17 | 6.15 | 6.09 | 2.34 | 2.35 | 2.36 | 2.38 |
| | 2.8 | 6.46 | 6.38 | 6.32 | 6.29 | 2.26 | 2.28 | 2.29 | 2.30 |
| | 5.6 | 6.87 | 6.78 | 6.75 | 6.70 | 2.18 | 2.19 | 2.20 | 2.21 |
| | 7.0 | 7.33 | 7.24 | 7.12 | 7.07 | 2.14 | 2.11 | 2.16 | 2.17 |
| | 11.1 | 7.56 | 7.47 | 7.41 | 7.36 | 2.01 | 2.01 | 2.01 | 2.02 |
| | 13.9 | 7.76 | 7.65 | 7.62 | 7.56 | 1.91 | 1.92 | 1.92 | 1.92 |
| | 16.7 | 7.96 | 7.85 | 7.79 | 7.73 | 1.82 | 1.82 | 1.82 | 1.82 |
| 18.0 | 8.08 | 7.96 | 7.88 | 7.82 | 1.78 | 1.77 | 1.77 | 1.77 | |
| 1090 | -15.0 | 5.57 | 5.49 | 5.47 | 5.44 | 2.31 | 2.39 | 2.36 | 2.37 |
| | -10.0 | 5.95 | 5.87 | 5.84 | 5.81 | 2.47 | 2.55 | 2.51 | 2.53 |
| | -7.0 | 6.23 | 6.15 | 6.12 | 6.09 | 2.62 | 2.71 | 2.67 | 2.69 |
| | -5.6 | 6.29 | 6.20 | 6.17 | 6.15 | 2.56 | 2.59 | 2.61 | 2.62 |
| | -2.8 | 6.35 | 6.26 | 6.23 | 6.20 | 2.46 | 2.48 | 2.50 | 2.51 |
| | 0.0 | 6.32 | 6.26 | 6.20 | 6.17 | 2.35 | 2.38 | 2.39 | 2.40 |
| | 2.8 | 6.52 | 6.44 | 6.41 | 6.38 | 2.28 | 2.30 | 2.31 | 2.32 |
| | 5.6 | 6.96 | 6.87 | 6.81 | 6.78 | 2.20 | 2.21 | 2.22 | 2.23 |
| | 7.0 | 7.42 | 7.33 | 7.21 | 7.15 | 2.16 | 2.13 | 2.18 | 2.19 |
| | 11.1 | 7.65 | 7.56 | 7.50 | 7.44 | 2.02 | 2.03 | 2.03 | 2.04 |
| | 13.9 | 7.88 | 7.76 | 7.70 | 7.65 | 1.93 | 1.93 | 1.93 | 1.93 |
| | 16.7 | 8.08 | 7.96 | 7.91 | 7.85 | 1.84 | 1.84 | 1.83 | 1.83 |
| 18.0 | 8.17 | 8.05 | 7.99 | 7.94 | 1.79 | 1.79 | 1.79 | 1.78 | |

Note: The table shows the case where the operation frequency of a compressor is fixed.

7. Noise Criterion Curves

7.1 Indoor Unit

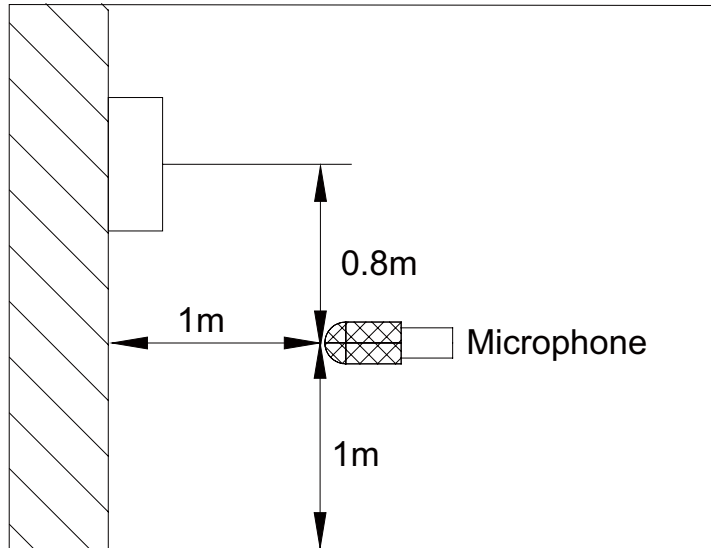

Notes:

- Sound measured at 1.0m away from the center of the unit.
- Data is valid at free field condition
- Data is valid at nominal operation condition
- Reference acoustic pressure $OdB = 20\mu Pa$
- Sound level will vary depending on a range of factors such as the construction -(acoustic absorption coefficient) of particular room in which the equipment is installed.
- The operating conditions are assumed to be standard.

42QH007D8S*/42QH009D8S*

42QH009D8SH

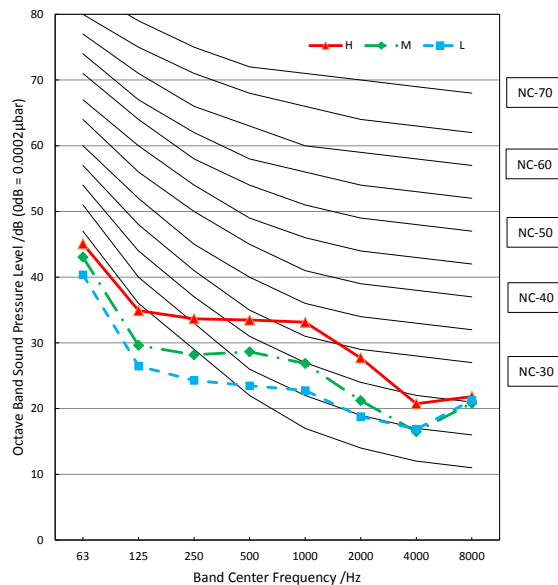
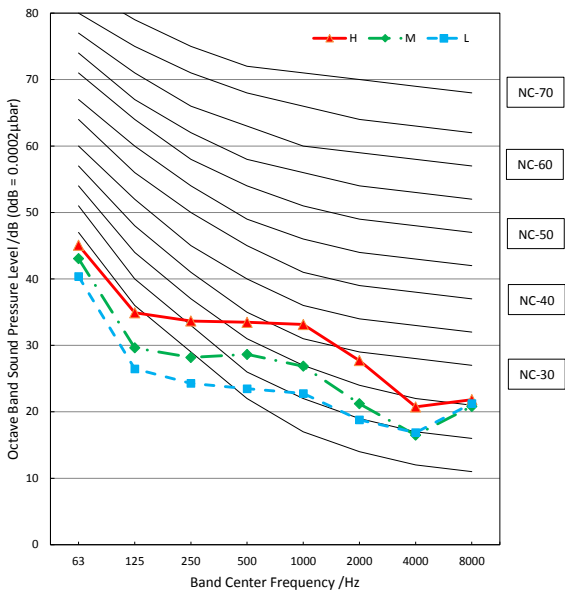

42QHGO12D8S*

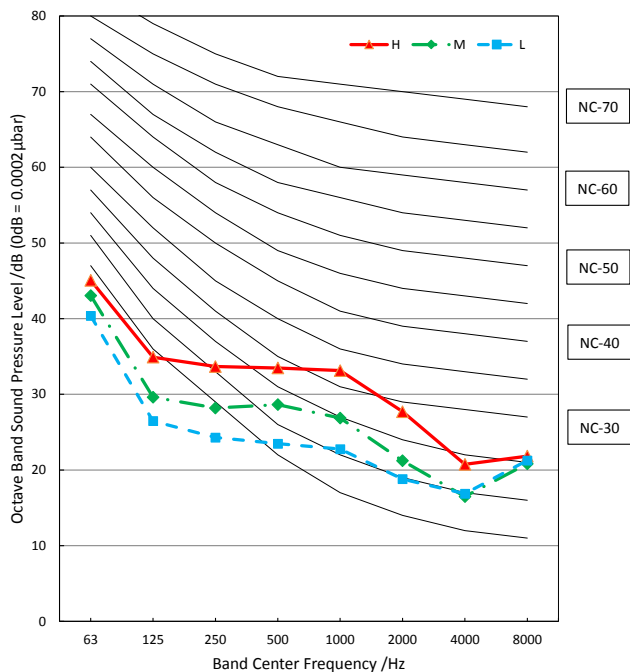

42QHGO12D8SH

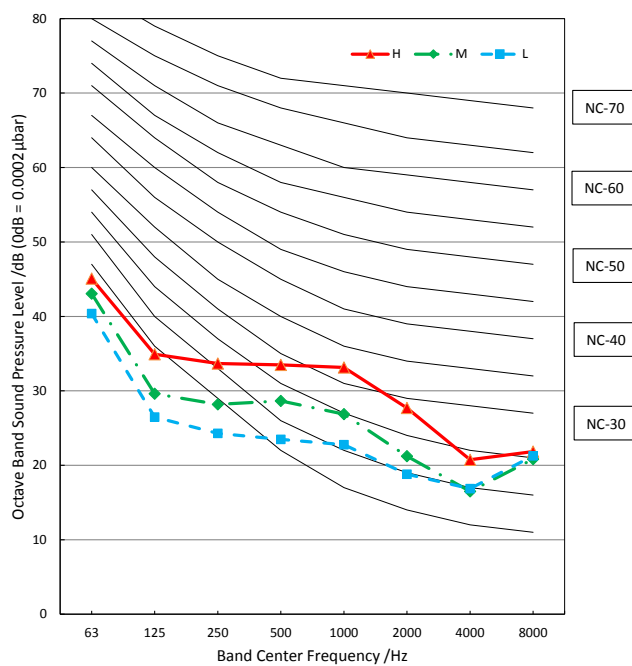

42QHGO18D8S*

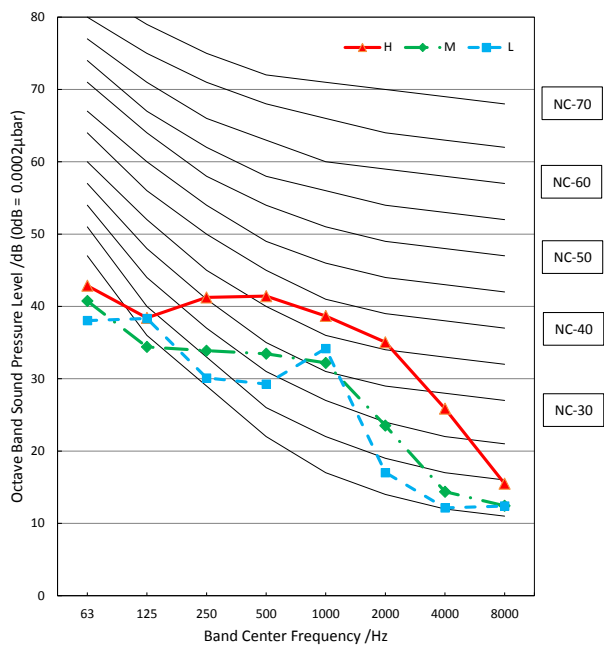

42QHGO22D8S*/42QHGO24D8S*

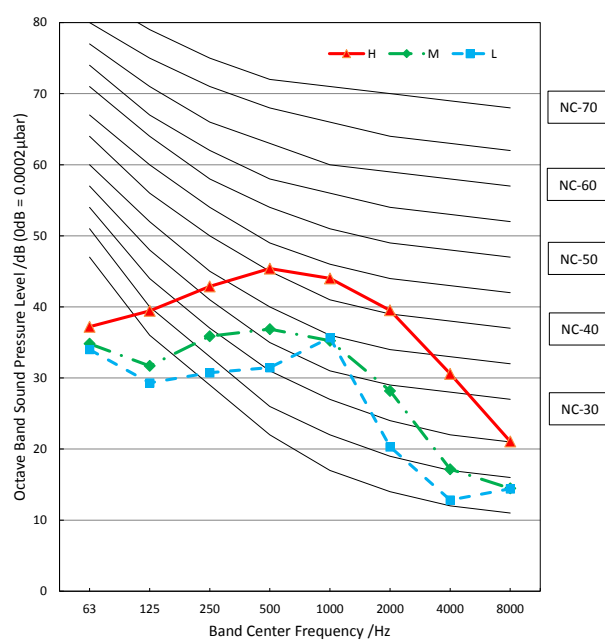

7.2 Outdoor Unit

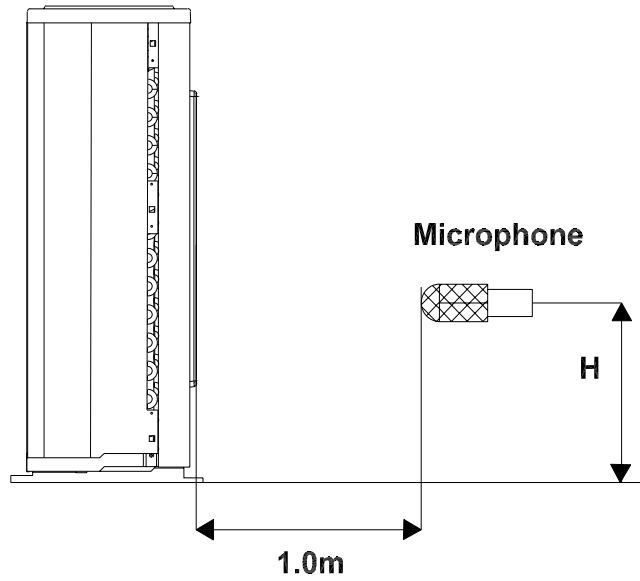

Note: $H = 0.5 \times \text{height of outdoor unit}$

Notes:

- Sound measured at 1.0m away from the center of the unit.
- Data is valid at free field condition
- Data is valid at nominal operation condition
- Reference acoustic pressure $OdB = 20\mu Pa$
- Sound level will vary depending on arrange off actors such as the construction (acoustic absorption coefficient) of particular room in which the equipment is installed.
- The operating conditions are assumed to be standard.

38QH007D8S*/38QH009D8S*

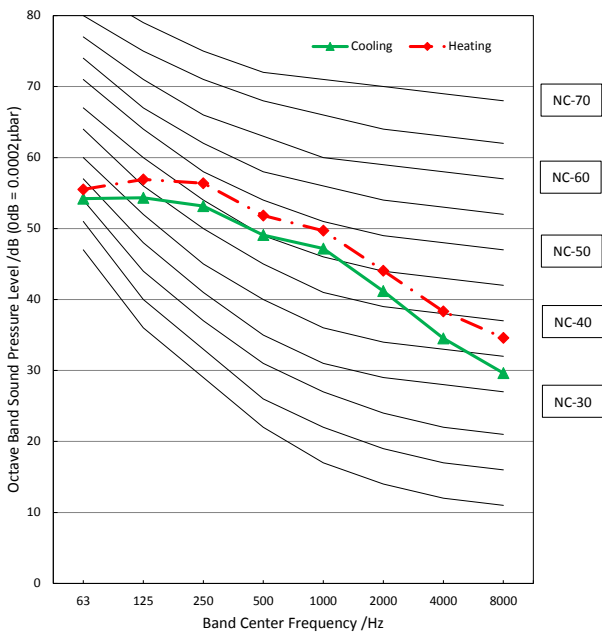

38QH009D8SH

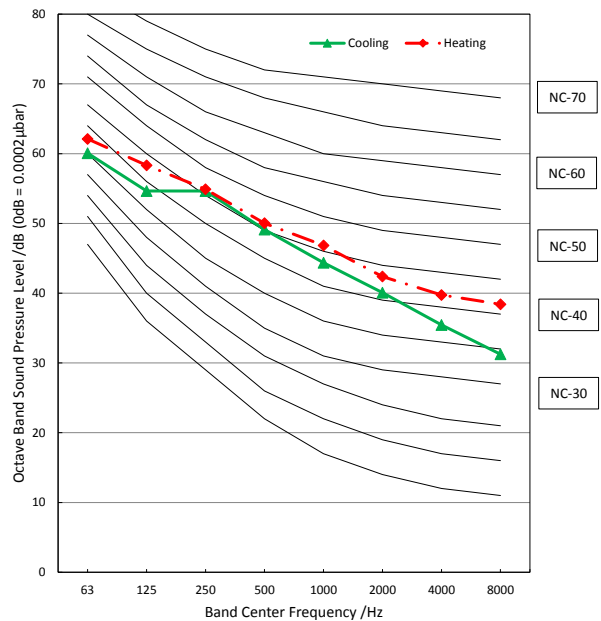

38QH012D8S*

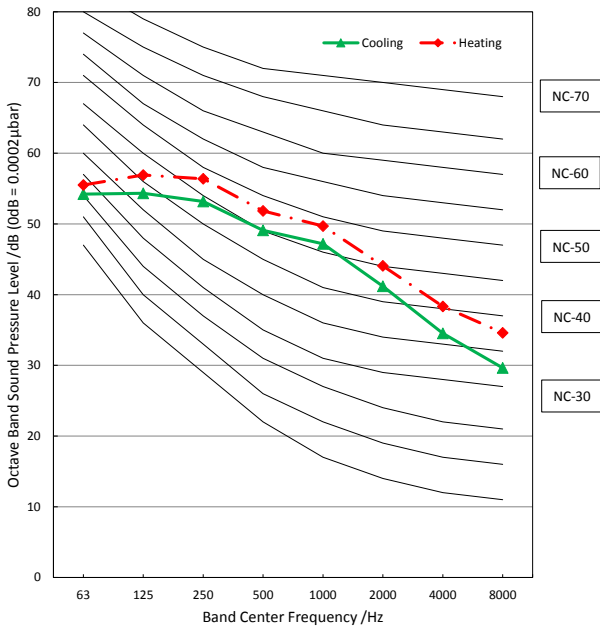

38QH012D8SH

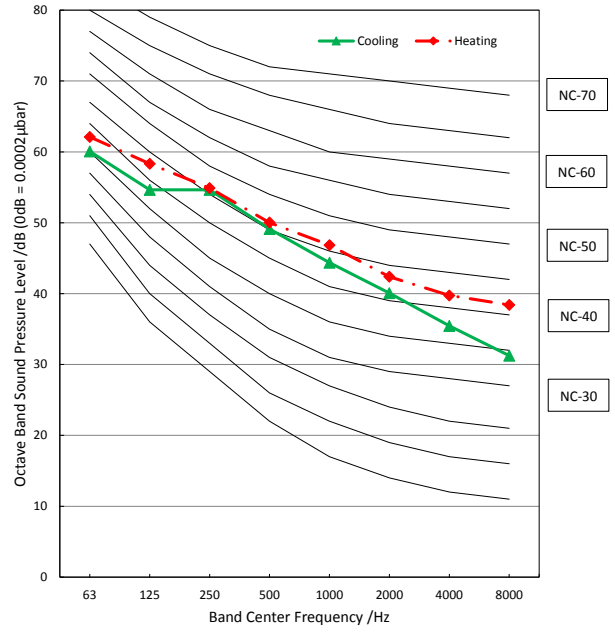

38QH018D8S*

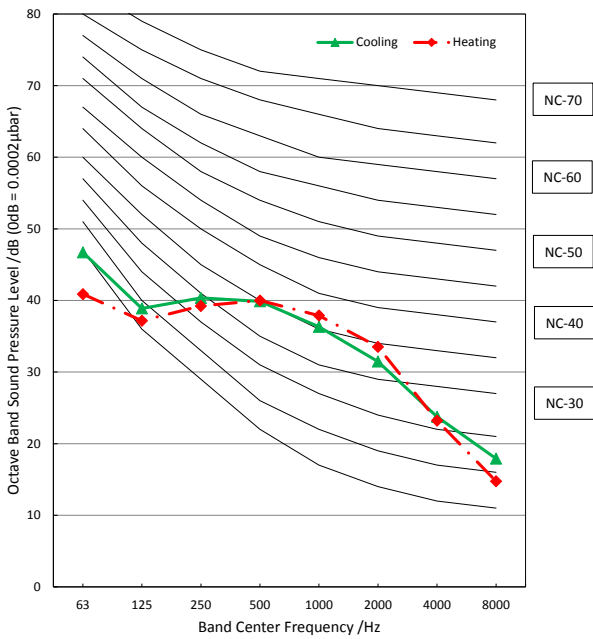

38QH022D8S*/38QH024D8S*

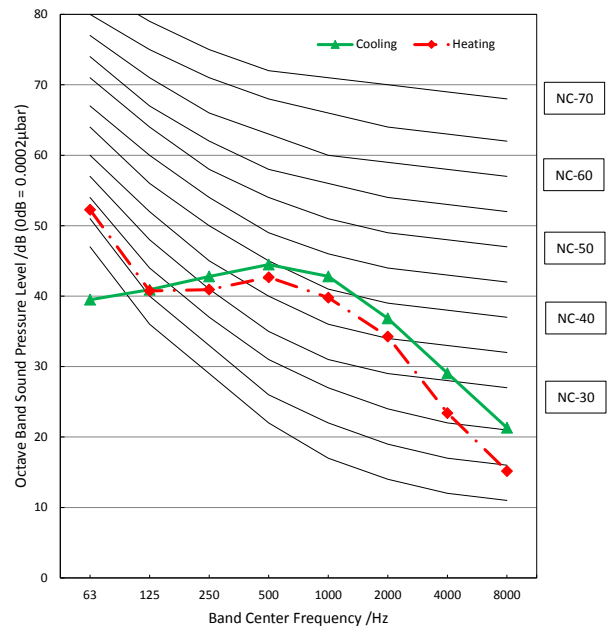

8. Electrical Characteristics

| Model | Indoor Unit | | | Power Supply | | IFM | |
|--------------|-------------|-------|-------------------------------|--------------|-----|-------|-------|
| | Phase | Hz | Voltage | MCA | MOP | kW | FLA |
| 42QHG007D8S* | 1 | 50/60 | 220-240 min:198 max:264 | -- | -- | 0.02 | 0.6 |
| 42QHG009D8S* | | | | -- | -- | 0.02 | 0.6 |
| 42QHG009D8SH | | | | -- | -- | 0.013 | 0.047 |
| 42QHG012D8S* | | | | -- | -- | 0.013 | 0.047 |
| 42QHG012D8SH | | | | -- | -- | 0.013 | 0.047 |
| 42QHG018D8S* | | | | -- | -- | 0.03 | 0.11 |
| 42QHG022D8S* | | | | -- | -- | 0.058 | 0.206 |
| 42QHG024D8S* | | | | -- | -- | 0.058 | 0.206 |

| Model | Outdoor Unit | | | Power Supply | | Compressor | | OFM | | |
|--------------|--------------|-------|-------------------------------|--------------|------|------------|------|-----|-------|-------|
| | Phase | Hz | Voltage | MCA | MOP | MSC | RLA | Qty | kW | FLA |
| 38QHG007D8S* | 1 | 50/60 | 220-240 min:198 max:264 | 3.95 | 6.35 | / | 2.4 | 1 | 0.02 | 0.475 |
| 38QHG009D8S* | | | | 3.95 | 6.35 | / | 2.4 | 1 | 0.02 | 0.475 |
| 38QHG009D8SH | | | | 8.4 | 13.8 | / | 5.4 | 1 | 0.034 | 0.823 |
| 38QHG012D8S* | | | | 3.95 | 6.35 | / | 2.4 | 1 | 0.02 | 0.475 |
| 38QHG012D8SH | | | | 8.4 | 13.8 | / | 5.4 | 1 | 0.034 | 0.823 |
| 38QHG018D8S* | | | | 11 | 18.5 | / | 7.5 | 1 | 0.034 | 0.823 |
| 38QHG022D8S* | | | | 13.5 | 23 | / | 9.45 | 1 | 0.08 | 0.82 |
| 38QHG024D8S* | | | | 13.5 | 23 | / | 9.45 | 1 | 0.08 | 0.82 |

Notes:

MCA: Minimum Circuit Amperes (A)

MOP: Maximum rating over current protective device

MSC: Maximum Starting Current

RLA: Rated Load Amperes (A)

IFM: Indoor Fan Motor

OFM: Outdoor Fan Motor

FLA: Full Load Amperes (A)

Product Features

Contents

| | | |
|------|---|----|
| 1. | Operation Modes and Functions | 49 |
| 1.1 | Abbreviation..... | 49 |
| 1.2 | Safety Features..... | 49 |
| 1.3 | Display Function..... | 49 |
| 1.4 | Fan Mode | 49 |
| 1.5 | Cooling Mode..... | 49 |
| 1.6 | Heating Mode(Heat Pump Units)..... | 51 |
| 1.7 | Auto-mode | 52 |
| 1.8 | Drying Mode..... | 52 |
| 1.9 | Forced Operation Function | 52 |
| 1.10 | Timer Function..... | 53 |
| 1.11 | Sleep Function | 53 |
| 1.12 | Follow me(Optional) | 53 |
| 1.13 | Auto-Restart Function..... | 53 |
| 1.14 | 8°C Heating | 53 |
| 1.15 | Silence (Optional) | 53 |
| 1.16 | ECO function..... | 53 |
| 1.17 | Electrical energy consumption control function..... | 54 |
| 1.18 | Breeze away function | 54 |
| 1.19 | Active Clean function..... | 54 |
| 1.20 | Wireless control(optional)..... | 54 |



Contents

| | | |
|-----|---|----|
| 2. | Remote Controller Functions | 55 |
| 2.1 | Infrared Wireless Remote Controller | 55 |

1. Operation Modes and Functions

1.1 Abbreviation

Unit element abbreviations

| Abbreviation | Element |
|--------------|----------------------------------|
| T1 | Indoor room temperature |
| T2 | Coil temperature of evaporator |
| T3 | Coil temperature of condenser |
| T4 | Outdoor ambient temperature |
| Tsc | Adjusted setting temperature |
| TP | Compressor discharge temperature |

1.2 Safety Features

Compressor three-minute delay at restart

Compressor functions are delayed for up to ten seconds upon the first startup of the unit, and are delayed for up to three minutes upon subsequent unit restarts.

Automatic shutoff based on discharge temperature

If the compressor discharge temperature exceeds a certain level for a period of time, the compressor ceases operation.

Automatic shutoff based on fan speed

If the indoor fan speed registers below 200RPM or over 2100RPM for an extended period of time, the unit ceases operation and the corresponding error code is displayed on the indoor unit.

Inverter module protection

The inverter module has an automatic shutoff mechanism based on the unit's current, voltage, and temperature. If automatic shutoff is initiated, the corresponding error code is displayed on the indoor unit and the unit ceases operation.

Indoor fan delayed operation

- When the unit starts, the louver is automatically activated and the indoor fan will operate after a period of setting time or the louver is in place.
- If the unit is in heating mode, the indoor fan is regulated by the anti-cold wind function.

Compressor preheating

Preheating is automatically activated when T4 is lower than setting temperature.

Sensor redundancy and automatic shutoff

- If one temperature sensor malfunctions, the air

conditioner continues operation and displays the corresponding error code, allowing for emergency use.

- When more than one temperature sensor is malfunctioning, the air conditioner ceases operation.

1.3 Display Function

Unit display functions

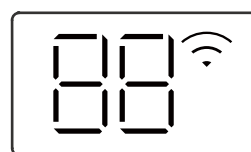

| Function | Display |
|---|-----------------------|
| Temperature | Set temperature value |
| Temperature (fan and Drying mode) | Room temperature |
| Activation of Timer ON, Fresh, Swing, Turbo, or Silent | ON (3s) |
| Cancellation of Timer OFF, Fresh, Swing, Turbo, or Silent | OF (3s) |
| Defrost | df |
| Active Clean | CL |
| Heating in room temperature under 8°C | FP |
| WiFi control (available on select units only) | WiFi symbol |

1.4 Fan Mode

When fan mode is activated:

- The outdoor fan and compressor cease operation.
- Temperature control is disabled and indoor room temperature is displayed.
- The indoor fan speed can be set to 1%~100%, or auto.
- The louver operations are identical to those in cooling mode.
- Auto fan: In fan-only mode, AC operates the same as auto fan in cooling mode with the temperature set at 24°C.(Tsc =24°C)

1.5 Cooling Mode

1.5.1 Compressor Control

Reach the configured temperature:

- 1) When the compressor runs continuously for within 120

minutes.

- If the following conditions are satisfied, the compressor ceases operation.
 - Calculated frequency(fb) is less than minimum limit frequency(FminC).
 - Compressor runs at FminC more than 10 minutes
 - T1 is lower than or equal to (Tsc-CDIFTEMP-0.5°C)

Note: CDIFTEMP is EEPROM setting parameter. It is 2°C usually.

- 2) When the compressor runs continuously for more than 120 minutes.
 - If the following conditions are satisfied, the compressor ceases operation.
 - Calculated frequency(fb) is less than minimum limit frequency(FminC).
 - Compressor runs at FminC more than 10 minutes.
 - T1 is lower than or equal to (Tsc-CDIFTEMP).

Note: CDIFTEMP is EEPROM setting parameter. It is 2°C usually.

- 3) If one of the following conditions is satisfied, not judge protective time.
 - Compressor running frequency(fr) is more than test frequency(TestFre).
 - Compressor running frequency is equal to test frequency, T4 is more than 15°C or T4 fault.
 - Change setting temperature.
 - Turbo or sleep function on/off
 - Various frequency limit shutdown occurs.

1.5.2 Indoor Fan Control

- 1) In cooling mode, the indoor fan operates continuously. The fan speed can be set to 1%-100%, or auto.
- 2) Auto fan

- Descent curve
 - When T1-Tsc is lower than or equal to 3.5°C, fan speed reduces to 80%;
 - When T1-Tsc is lower than or equal to 1°C, fan speed reduces to 60%;
 - When T1-Tsc is lower than or equal to 0.5°C, fan speed reduces to 40%;
 - When T1-Tsc is lower than or equal to 0°C, fan speed reduces to 20%;
 - When T1-Tsc is lower than or equal to -0.5°C, fan

speed reduces to 1%.

- Rise curve
 - When T1-Tsc is higher than 0°C, fan speed increases to 20%;
 - When T1-Tsc is higher than 0.5°C, fan speed increases to 40%;
 - When T1-Tsc is higher than 1°C, fan speed increases to 60%;
 - When T1-Tsc is higher than 1.5°C, fan speed increases to 80%;
 - When T1-Tsc is higher than 4°C, fan speed increases to 100%.

1.5.3 Outdoor Fan Control

- The outdoor unit will be run at different fan speed according to T4 and compressor running frequency..
- For different outdoor units, the fan speeds are different.

1.5.4 Condenser Temperature Protection

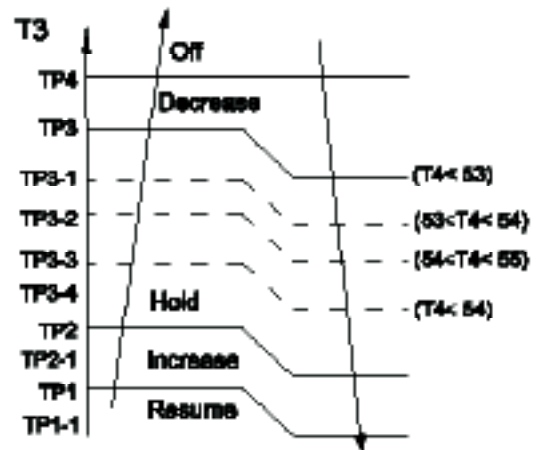

When the condenser temperature exceeds a configured value, the compressor ceases operation.

1.5.5 Evaporator Temperature Protection

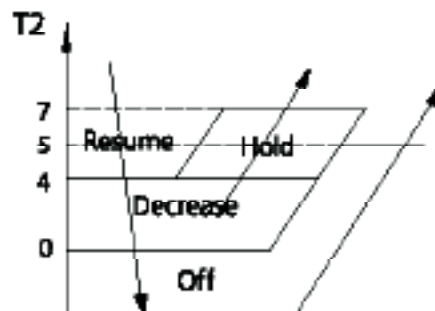

- Off: Compressor stops.
- Decrease: Decrease the running frequency to the lower level per 1 minute.

- Hold: Keep the current frequency.
- Resume: No limitation for frequency.

1.6 Heating Mode(Heat Pump Units)

1.6.1 Compressor Control

1) Reach the configured temperature

- If the following conditions are satisfied, the compressor ceases operation.
 - Calculated frequency(fb) is less than minimum limit frequency(FminH).
 - Compressor runs at FminH more than 10 minutes.
 - T1 is higher than or equal to Tsc+ HDIFTEMP2.

Note: HDIFTEMP2 is EEPROM setting parameter. It is 2°C usually.

- If one of the following conditions is satisfied, not judge protective time.
 - Compressor running frequency(fr) is more than test frequency(TestFre).
 - When compressor running frequency is equal to test frequency, T4 is more than 15°C or T4 fault.
 - Change setting temperature.
 - Turbo or sleep function on/off.

2) When the current is higher than the predefined safe value, surge protection is activated, causing the compressor to cease operations.

1.6.2 Indoor Fan Control:

1) In heating mode, the indoor fan operates continuously. The fan speed can be set to 1%-100%, or mute. And the anti-cold wind function has the priority.

- Anti-cold air function
 - The indoor fan is controlled by the indoor temperature T1 and indoor unit coil temperature T2.

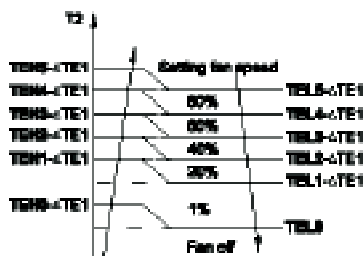

| | |
|---|---|
| $T1 \geq 19^{\circ}\text{C}(66.2^{\circ}\text{F})$ | $\Delta TE1=0$ |
| $15^{\circ}\text{C}(59^{\circ}\text{F}) \leq T1 < 19^{\circ}\text{C}(66.2^{\circ}\text{F})$ | $\Delta TE1=19^{\circ}\text{C}-T1$ ($34.2^{\circ}\text{F}-T1$) |
| $T1 < 15^{\circ}\text{C}(59^{\circ}\text{F})$ | $\Delta TE1=4^{\circ}\text{C}(7.2^{\circ}\text{F})$ |

2) Auto fan

- Rise curve
 - When T1-Tsc is higher than -1.5°C, fan speed reduces to 80%;
 - When T1-Tsc is higher than 0°C, fan speed reduces to 60%;
 - When T1-Tsc is higher than 0.5°C, fan speed reduces to 40%;
 - When T1-Tsc is higher than 1°C, fan speed reduces to 20%.
- Descent curve
 - When T1-Tsc is lower than or equal to 0.5°C, fan speed increases to 20%;
 - When T1-Tsc is lower than or equal to 0°C, fan speed increases to 60%;
 - When T1-Tsc is lower than or equal to -1.5°C, fan speed increases to 80%;
 - When T1-Tsc is lower than or equal to -3°C, fan speed increases to 100%.

1.6.3 Outdoor Fan Control:

- The outdoor unit will be run at different fan speed according to T4 and compressor running frequency.
- For different outdoor units, the fan speeds are different.

1.6.4 Defrosting Mode

- The unit enters defrosting mode according to changes in the temperature value of T3, T4 as well as the compressor running time.
- In defrosting mode, the compressor continues to run, the indoor and outdoor motor will cease operation, the defrost light of the indoor unit will turn on, and the "df" symbol is displayed.
- If any one of the following conditions is satisfied, defrosting ends and the machine switches to normal heating mode:
 - T3 rises above TCDE1°C.
 - T3 maintained above TCDE2°C for 80 seconds.
- Unit runs for 15 minutes consecutively in defrosting mode.
- If T3 is lower than -3°C and compressor running time is more than 120 minutes, If any one of the following conditions is satisfied, defrosting ends and the machine switches to normal heating mode:
 - T3 rises above TCDE1+4°C.
 - T3 maintained above TCDE2+4°C for 80 seconds.
 - Unit runs for 15 minutes consecutively in defrosting mode.

- If T4 is lower than or equal to -22°C and compressor running time is more than TIMING_DEFROST_TIME, if any one of the following conditions is satisfied, defrosting ends and the machine switches to normal heating mode:
 - Unit runs for 10 minutes consecutively in defrosting mode.
 - T3 rises above 10°C .

1.6.5 Evaporator Temperature Protection

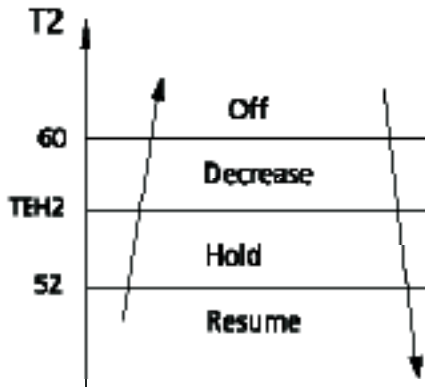

- Off: Compressor stops.
- Decrease: Decrease the running frequency to the lower level per 20 seconds.
- Hold: Keep the current frequency.
- Resume: No limitation for frequency.

1.7 Auto-mode

- This mode can be selected with the remote controller and the setting temperature can be changed between $16^{\circ}\text{C}\sim 30^{\circ}\text{C}$.
- In auto mode, the machine selects cooling, heating, auto-drying or fan-only mode on the basis of T1, Ts, T4 and relative humidity.

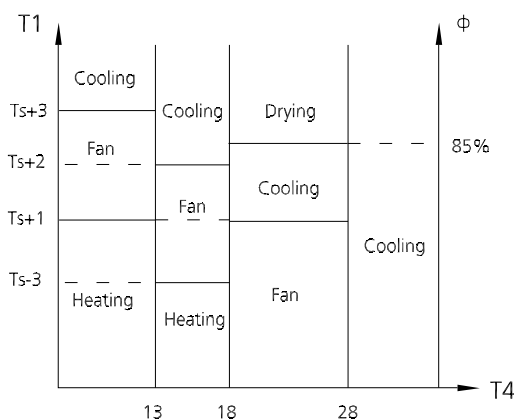

- If the setting temperature is modified, the machine selects a new running function.

1.8 Drying mode

- In drying mode, AC operates the same as auto fan in cooling mode.
- All protections are activated and operate the same as they do that in cooling mode.
- Low Room Temperature Protection

If the room temperature is lower than 10°C , the compressor ceases operations and does not resume until room temperature exceeds 12°C .

1.9 Forced operation function

- Forced cooling mode:

The compressor and outdoor fan continue to run (fixed at rated frequency), and the indoor fan runs at rated speed. After running for 30 minutes, the AC will switch to auto mode with a preset temperature of 24°C .

- Forced auto mode:

Forced auto mode operates the same as normal auto mode with a preset temperature of 24°C .

- The unit exits forced operation when it receives the following signals:

- Switch on
- Switch off
- Timer on
- Timer off
- Sleep mode
- Follow me
- Changes in:
 - mode
 - fan speed
 - setting temperature

- Forced defrosting mode:

- Press AUTO/COOL button continuously for 5s under forced cooling mode to enter this mode.
- Indoor fan will stop, defrosting lamp will light on.
- Quit this mode and turn off the unit when:
 - quit normal defrosting
 - turn off by RC
 - Press AUTO/COOL button continuously for 5s again

1.10 Timer function

- Timing range is 24 hours.
- Timer on. The machine will turn on automatically

when reaching the setting time.

- Timer off. The machine will turn off automatically when reaching the setting time.
- Timer on/off. The machine will turn on automatically when reaching the setting "on" time, and then turn off automatically when reaching the setting "off" time.
- Timer off/on. The machine will turn off automatically when reaching the setting "off" time, and then turn on automatically when reaching the setting "on" time.
- The timer function will not change the AC current operation mode. Suppose AC is off now, it will not start up firstly after setting the "timer off" function. And when reaching the setting time, the timer LED will be off and the AC running mode has not been changed.
- The setting time is relative time.
- The AC will quit the timer function when it has malfunction

1.11 Sleep function

- The sleep function is available in cooling, heating, or auto mode.
- The operational process for sleep mode is as follows:
 - When cooling, the temperature rises 1°C (to not higher than 30°C) every hour. After 2 hours, the temperature stops rising and the indoor fan is fixed at low speed.
 - When heating, the temperature decreases 1°C (to not lower than 16°C) every hour. After 2 hours, the temperature stops decreasing and the indoor fan is fixed at low speed. Anti-cold wind function takes priority.
- The operating time for sleep mode is 8 hours, after which, the unit exits this mode.
- The timer setting is available in this mode.

1.12 Follow me

- If you press "Follow Me" on the remote, the indoor unit will beep. This indicates the follow me function is active.
- Once active, the remote control will send a signal every 3 minutes, with no beeps. The unit automatically sets the temperature according to the measurements from the remote control.
- The unit will only change modes if the information from the remote control makes it necessary, not from the unit's temperature setting.
- If the unit does not receive a signal for 7 minutes or

you press "Follow Me," the function turns off. The unit regulates temperature based on its own sensor and settings.

1.13 Auto-Restart function

- The indoor unit has an auto-restart module that allows the unit to restart automatically. The module automatically stores the current settings and, in the case of a sudden power failure, will restore those setting automatically within 3 minutes after power returns.
- If there is a power failure while the unit is running, the compressor starts 3 minutes after the unit restarts. If the unit was already off before the power failure, the unit stands by.

1.14 8°C Heating

In heating mode, the temperature can be set to as low as 8°C, preventing the indoor area from freezing if unoccupied during severe cold weather.

1.15 Silence

Press "Silence" on the remote control to enable the SILENCE function. While this function is active, the indoor unit will run at faint breeze (1% fan speed), which reduces noise to the lowest possible level.

1.16 ECO function

- Used to enter the energy efficient mode.
 - Under cooling mode, press ECO button, the remote controller will adjust the temperature automatically to 24°C, fan speed of Auto to save energy (but only if the set temperature is less than 24°C). If the set temperature is more than 24°C and 30°C, press the ECO button, the fan speed will change to Auto, the set temperature will remain unchanged.
- When AC receives signals, such as switch off, Turbo operation, Silence operation, Self clean operation, Forced cooling operation, mode setting, Sleeping mode, or adjusting the set temperature to less than 24°C, it will quit the ECO operation.
- Operation time in ECO mode is 8 hours. After 8 hours the AC quits this mode.
- When there's any one temperature sensor in malfunction, the AC will quit ECO mode.
- Indoor fan will run at auto fan when enter into the ECO mode. The setting temperature and setting fan

speed can be changed through remote controller signal.

1.17 Electrical energy consumption control function

Press the "Gear" button on remote controller to enter the energy efficient mode in a sequence of following:

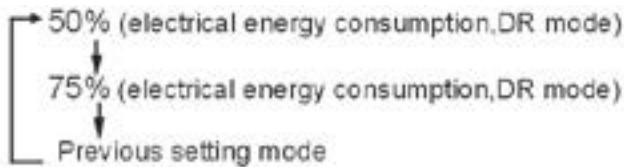

Turn off the unit or activate ECO, sleep, Super cool, Silence or self clean function will quit this function.

1.18 Breeze Away function

- This feature avoids direct airflow blowing on the body and makes you feel indulging in silky coolness.
- NOTE: This feature is available under cooling mode, fan-only mode and drying mode.

1.19 Active Clean function

- The Active Clean Technology washes away dust, mold, and grease that may cause odors when it adheres to the heat exchanger by automatically freezing and then rapidly thawing the frost. The internal wind wheel then keeps operating to blow-dry the evaporator, thus preventing the growth of mold and keeping the inside clean.
- When this function is turned on, the indoor unit display window appears "CL", after 20 to 45 minutes, the unit will turn off automatically and cancel Active Clean function.

1.20 Wireless Control (Optional)

- Wireless control allows you to control your air conditioner using your mobile phone and a Wireless connection.
- For the USB device access, replacement, maintenance operations must be carried out by professional staff.

2. Remote Controller Functions

2.1 Infrared Wireless Remote Controller

2.1.1. RG67G/BGEF (Standard)

Remote Controller Specifications

| Model | RG67G/BGEF |
|-------------------------------|---------------------------------|
| Rated Voltage | 3.0V (Dry batteries R03/LR03x2) |
| Reaching Distance | 8m |
| Environment Temperature Range | -5°C~60°C(23°F~140°F) |

Buttons and Functions

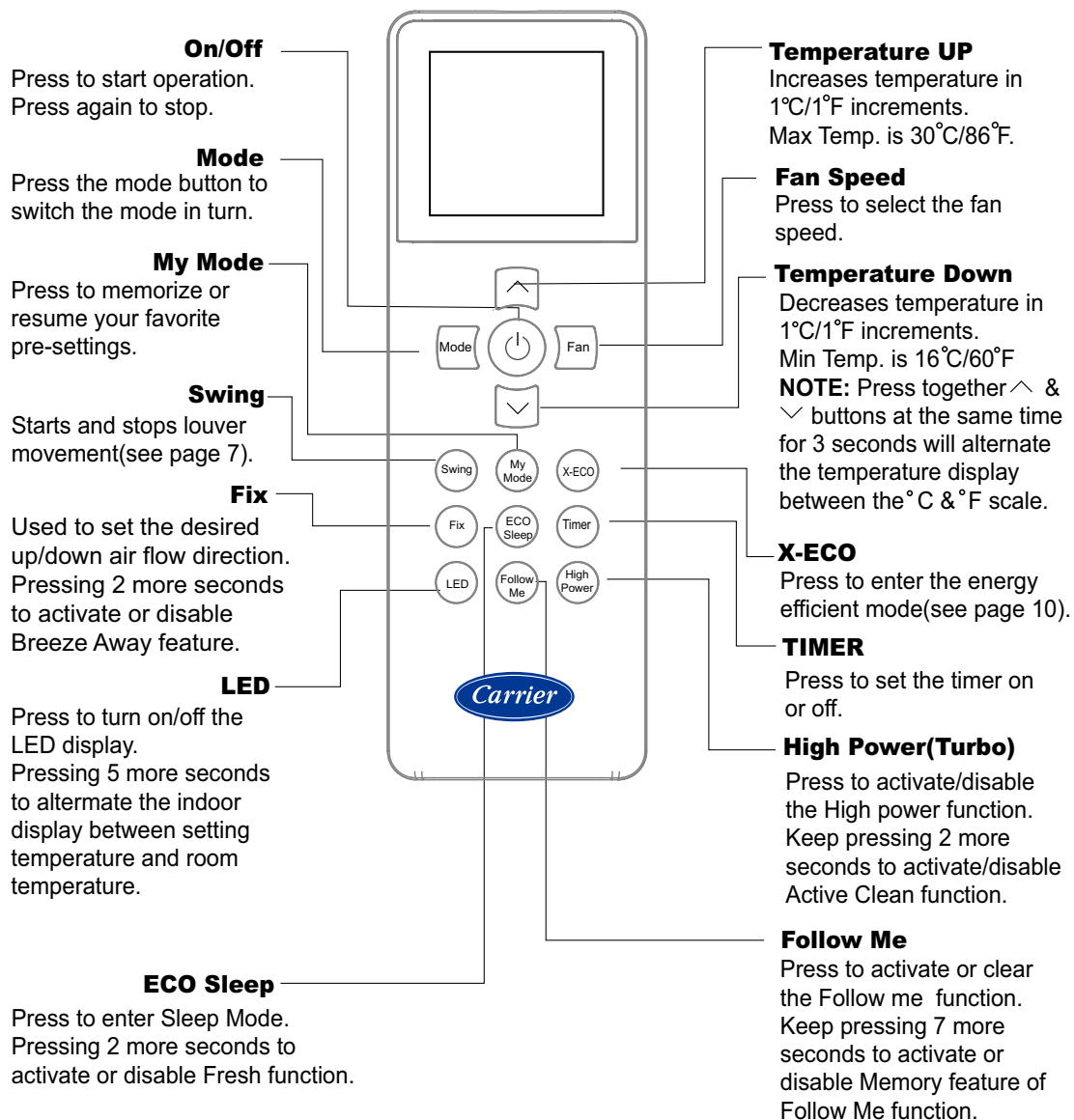

How To Use The Basic Functions

! ATTENTION Before operation, please ensure the unit is plugged in and power is available.

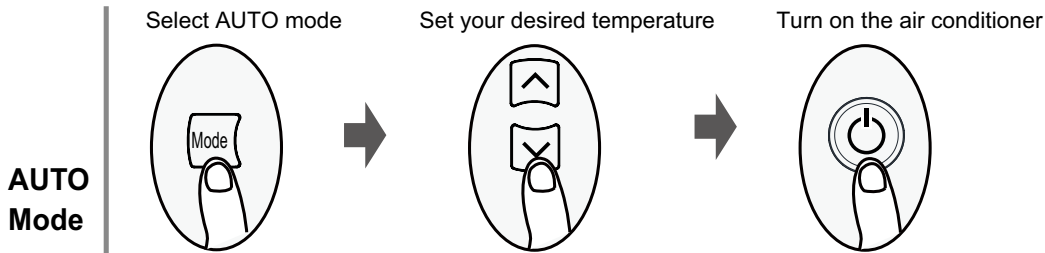

NOTE:

1. In AUTO mode for heat pump system, the air conditioner can automatically choose the mode of Cool, Heat or Fan by sensing the difference between the actual room temperature and setting temperature.
2. In AUTO mode for cooling only system, the air conditioner can automatically choose the mode of Cool or Fan by sensing the difference between the actual room temperature and setting temperature.
3. In AUTO mode, fan speed can not be set.

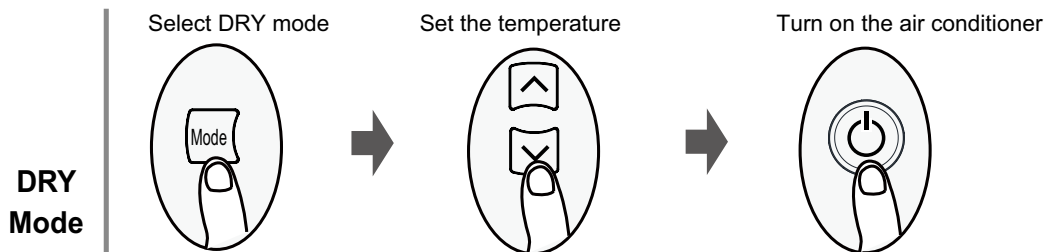
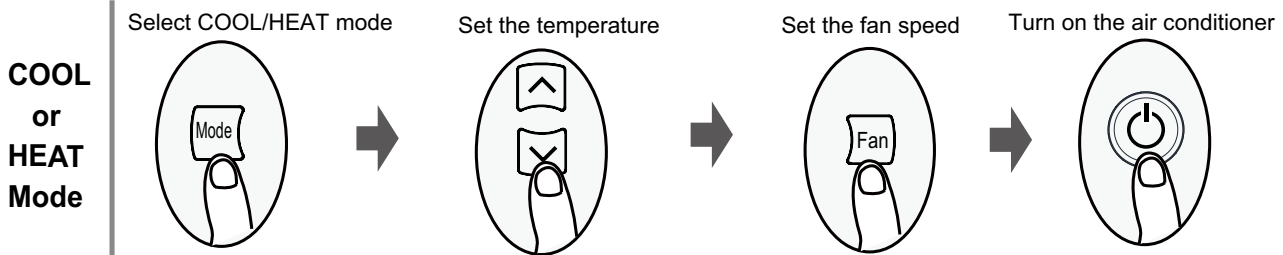

NOTE:

In DRY mode, fan speed can not be set since it has already been automatically controlled.

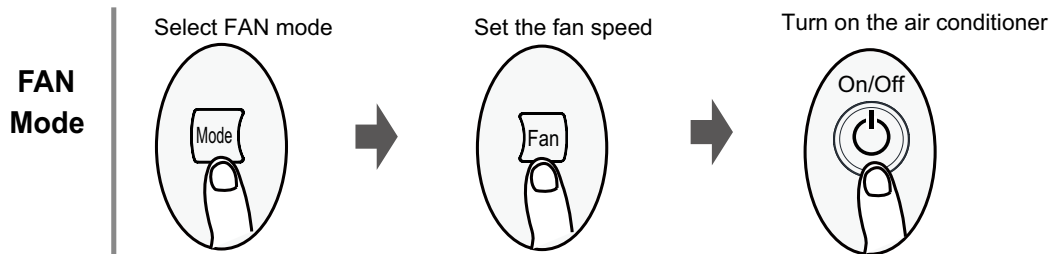

How To Use Advanced Function

Swing

Press Swing button

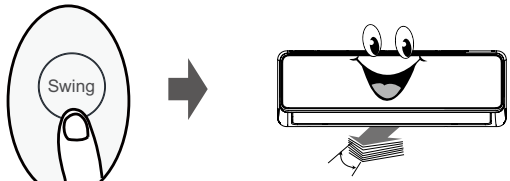

The horizontal louver will swing up and down automatically when pressing Swing button. Press again to make it stop.

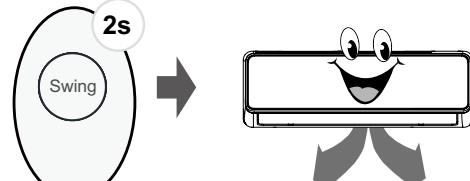

Keep pressing this button more than 2 seconds, the vertical louver swing function is activated. (Model dependent)

Fix or Breeze Away

Press Fix button

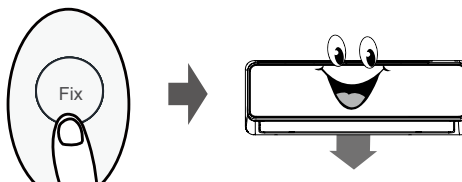

The horizontal louver will move an angle of 6 degree for each press. Press the button until the louver reach your prefer location.

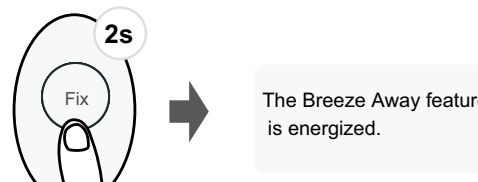

Keep pressing this button more than 2 seconds, the Breeze Away feature is activated and will avoid direct air flow blowing on the body and make you feel indulging in silky coolness.

ECO Sleep

Press ECO Sleep button under Auto/Cool/Heat mode

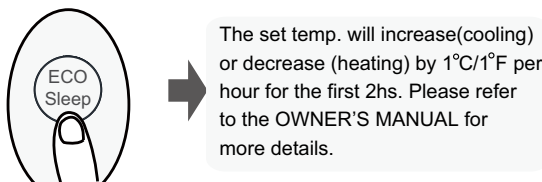

The set temp. will increase (cooling) or decrease (heating) by 1°C/1°F per hour for the first 2hs. Please refer to the OWNER'S MANUAL for more details.

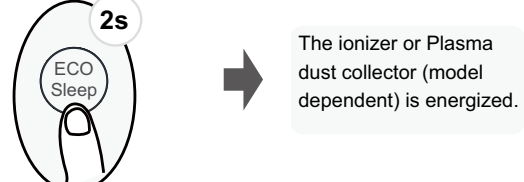

The ionizer or Plasma dust collector (model dependent) is energized.

This Sleep operation saves energy and improves night time comfort by synchronising with the body's metabolism. The sleep function is not available in Fan or Dry mode.

My Mode

Press this button more than 2 seconds

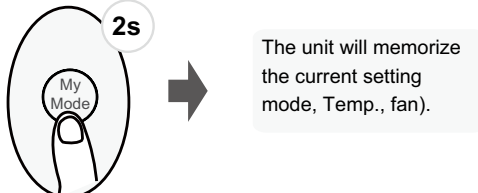

The unit will memorize the current setting mode, Temp., fan).

Press this button

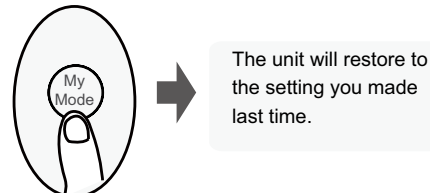

The unit will restore to the setting you made last time.

My Mode function enable you to memorize or restore your favorite settings (mode, temperature and fan speed). The default memorized setting is AUTO mode, 26°C/78°F and AUTO fan.

Follow Me

Press this button under COOL or HEAT operating Mode

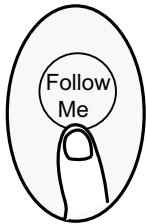

The controller will display the actual temp. at its location and send this signal to indoor unit every 3 minutes

Press this button to activate Follow me. This function can adjust room temperature base on the controller's sensor and make you comfort.

Note: Please put the controller in the location where can ensure the indoor unit can receive the signal.

Press this button more than 7 seconds

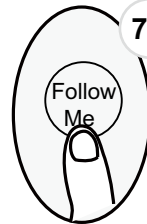

The Memory feature of Follow Me function is energized.

"On" displays for 3 seconds when the Memory feature is energized. "OF" displays for 3 seconds when the Memory feature is stopped.

Turn on/off, shift the mode or power failure will not stop the Memory feature.

LED

Press LED button

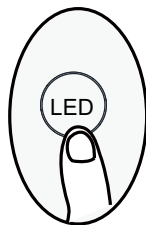

Press this button to turn on and turn off the display on the indoor unit.

Press this button more than 5 seconds

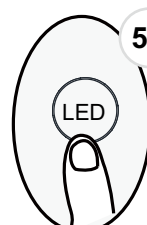

Keep pressing this button more than 5 seconds, the indoor unit will display the actual room temperature. Press more than 5 seconds again will revert back to display the setting temperature.

High Power (Turbo) or Active Clean

Press this button

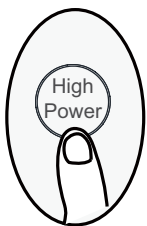

The unit will operate at the biggest capacity output to reach the setting Temp. quickly.

Press this button to activate High Power(Turbo) feature. It enables the unit to reach the set temperature in the shortest time. Press it again to disable it.(Model dependent)

Press this button more than 2 seconds

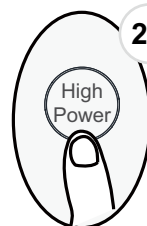

The Active Clean feature is energized.

The Active Clean Technology washes away dust, mold, and grease that may cause odors when it adheres to the heat exchanger by automatically freezing and then rapidly thawing the frost.

F.P.

Press this button 2 times during one second under HEAT Mode and setting temperature of 16°C/60°F.

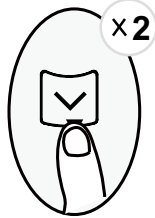



The unit will operate at high fan speed (while compressor on) with temperature automatically set to 8°C/46°F.

Note: This function is for heat pump air conditioner only.

Press this button 2 times under HEAT Mode and setting temperature of 16°C/60°F to activate the freeze protection function. It will help to keep the room above 0°C/32°F (freezing point) in severe cold winter.

Press On/Off, Sleep, Mode, Fan and Temp. button while operating will cancel this function.

Press together  button and  button at the same time more than 2 seconds to activate Lock Mode 1 function.

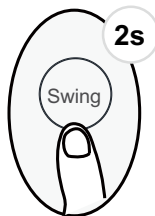

Lock Mode 1

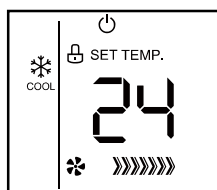
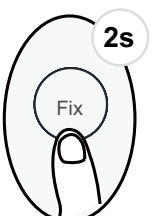

+



Lock symbol displays

Enter lock mode 1 by pressing  and  button at the same time more than 2 seconds. At lock mode 1, all buttons will not response except press these two buttons again to disable locking.

Lock Mode 2

Press together TIMER button and X-ECO button at the same time more than 2 seconds to activate lock mode 2 function.

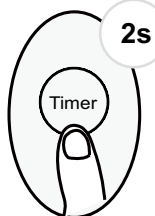

+

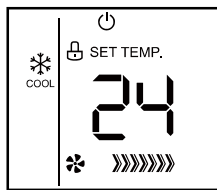
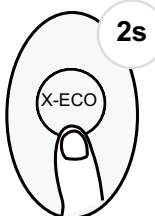

Lock symbol displays

Enter lock mode 2 by pressing TIMER and X-ECO button at the same time more than 2 seconds. At lock mode 2, all buttons will not response except press ON/OFF, TEMP UP and DOWN buttons or press these two buttons again to disable locking.

Silence

Keep pressing Fan button for more than 2 seconds to activate/disable Silence function.



Due to low frequency operation of compressor, it may result in insufficient cooling and heating capacity. Press ON/OFF, Mode, Sleep button, turn on F.P. or Self clean function while operating will cancel silence function. (Model dependent)

X-ECO

Press this button under COOL Mode to enter the energy efficient mode.

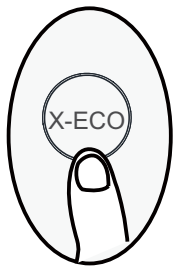

Press X-ECO button to enter the energy efficient mode in a sequence of following:
 ECO → GEAR(75%) → GEAR(50%) → Previous setting mode → ECO.....

Note: This function is only available under COOL mode.

ECO operation:

Under cooling mode, press this button, the remote controller will adjust the temperature automatically to 24°C/75°F, fan speed of Auto to save energy (only when the set temperature is less than 24°C/75°F). If the set temperature is above 24°C/75°F, press the X-ECO button, the fan speed will change to Auto, the set temperature will remain unchanged.

Note:

Pressing the X-ECO button, or modifying the mode or adjusting the set temperature to less than 24°C/75°F will stop ECO operation.

Under ECO operation, the set temperature should be 24°C/75°F or above, it may result in insufficient cooling. If you feel uncomfortable, just press the X-ECO button again to stop it.

GEAR operation:

Press the X-ECO button to enter the GEAR operation as following:

75%(up to 75% electrical energy consumption)



50%(up to 50% electrical energy consumption)



Previous setting mode.







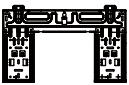

Under GEAR operation, the display on the remote controller will alternate between electrical energy consumption and set temperature.

Installation

Contents

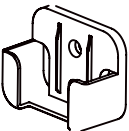
| | |
|---|----|
| Accessories | 61 |
| 1. Installation Overview | 62 |
| 2. Location Selection | 64 |
| 3. Indoor Unit Installation..... | 65 |
| 4. Outdoor Unit Installation | 70 |
| 5. Refrigerant Pipe Installation | 71 |
| 6. Vacuum Drying and Leakage Checking | 72 |
| 7. Additional Refrigerant Charge | 73 |
| 8. Electrical and Gas Leak Checks | 74 |
| 9. Test Operation..... | 74 |

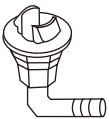
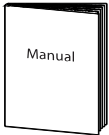
Accessories

| Name | Shape | Quantity | |
|---|---|--------------------------------------|--|
| Mounting plate |  | 1 | |
| Clip anchor |  | 5~8(depending on models) | |
| Mounting plate fixing screw ST3.9 X 25 |  | 5~8(depending on models) | |
| Remote controller |  | 1 | |
| Fixing screw for remote controller holder ST2.9 x 10 |  | 2 | Optional Parts |
| Remote controller holder |  | 1 | |
| Dry battery AAA.LR03 |  | 2 | |
| Seal |  | 1(for cooling & heating models only) | |
| Drain joint |  | | |
| Installation& Owner's manual |  | 1 | |
| Remote controller manual |  | 1 | |
| Small Filter(Need to be installed on the back of main air filter by the authorized technician while installing the machine) |  | 1~2(depending on models) | |
| Connecting pipe assembly | Liquid side | Φ6.35 (1/4in) | Parts you must purchase. Consult the dealer about the pipe size. |
| | | Φ9.52 (3/8in) | |
| | Gas side | Φ9.52 (3/8in) | |
| | | Φ12.7 (1/2in) | |
| | | Φ16 (5/8in) | |
| | | Φ19 (3/4in) | |

Magnetic ring and belt(if supplied ,please refer to the wiring diagram to install it on the connective cable.)

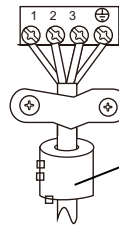

Pass the belt through the hole of the Magnetic ring to fix it on the cable

Varies by models

1. Installation Overview

Installation Order

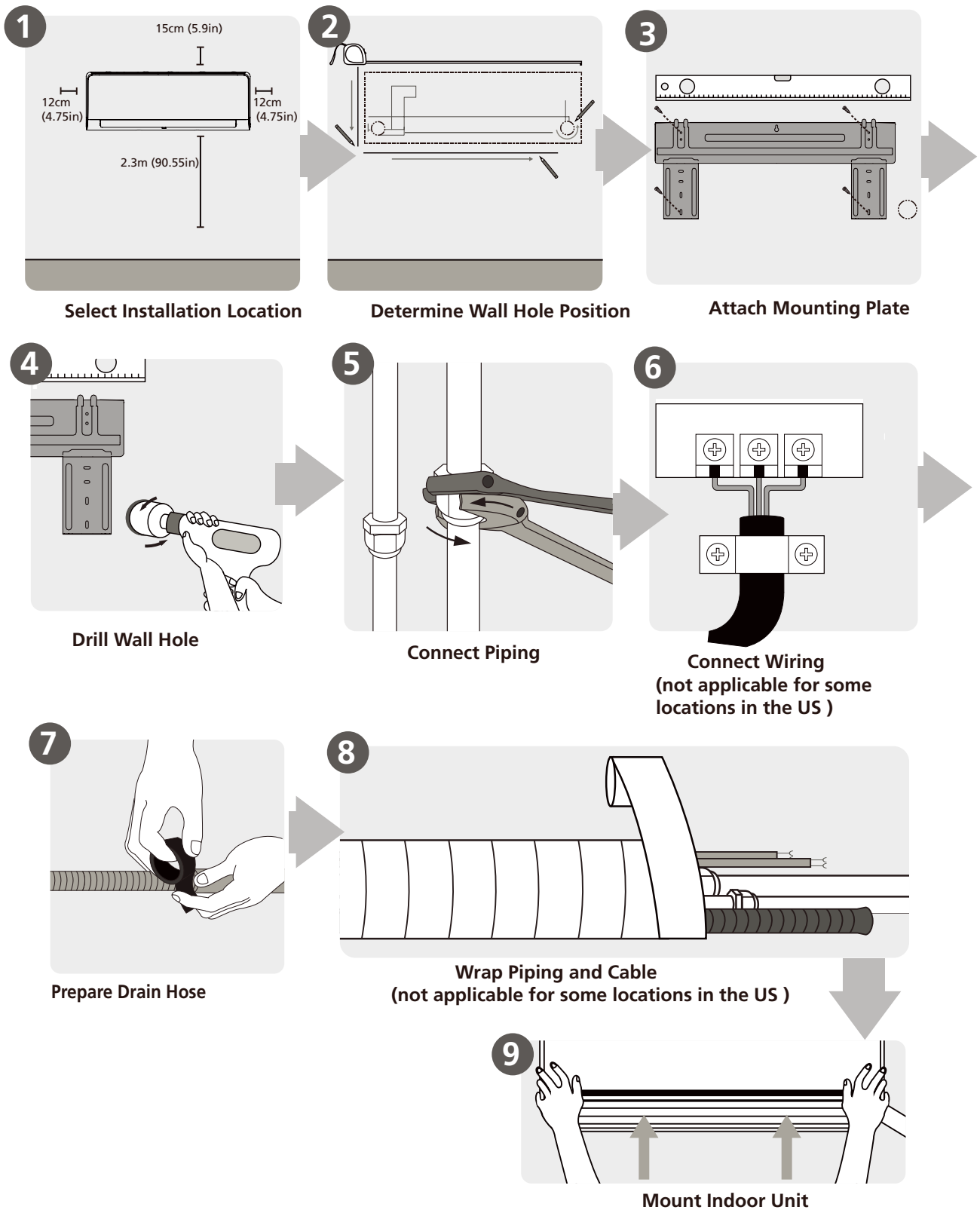

2. Location selection

2.1 Unit location selection can refer to installation manual.

2.2 DO NOT install the unit in the following locations:

- Where oil drilling or fracking is taking place.
- Coastal areas with high salt content in the air.
- Areas with caustic gases in the air, such as near hot springs.
- Areas with power fluctuations, such as factories.
- Enclosed spaces, such as cabinets.
- Areas with strong electromagnetic waves.
- Areas that store flammable materials or gas.
- Rooms with high humidity, such as bathrooms or laundry rooms.
- If possible, DO NOT install the unit where it is exposed to direct sunlight.

2.3 The minimum distance between the outdoor unit and walls described in the installation guide does not apply to airtight rooms. Be sure to keep the unit unobstructed in at least two of the three directions (M, N, P)

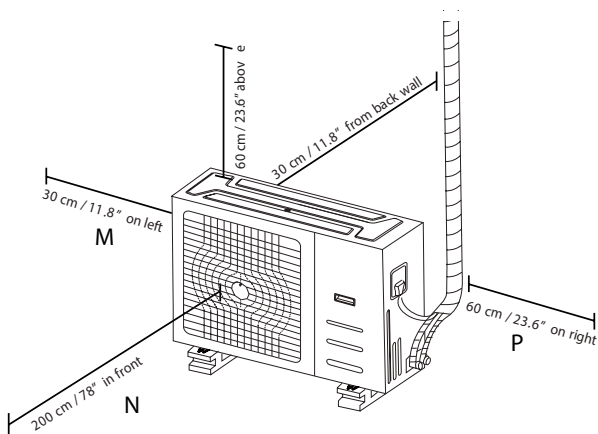

2.4 Rows of series installation

The relations between H, A and L are as follows.

| | L | A |
|-------|----------------------|-----------------------|
| L ≤ H | $L \leq 1/2H$ | 25 cm / 9.8" or more |
| | $1/2H < L \leq H$ | 30 cm / 11.8" or more |
| L > H | Can not be installed | |

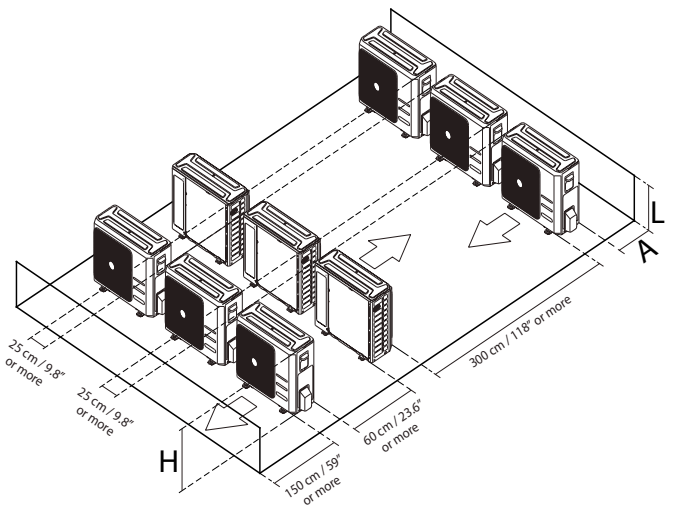

DO NOT install the rows of series like following figure.

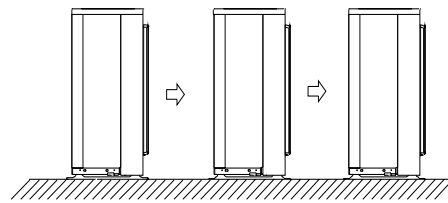

2.5 If the location is exposed to strong winds (for example: near a seaside), the unit must be placed against the wall to shelter it from the wind. If necessary, use an awning.

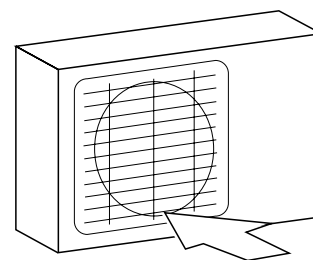

DO NOT Strong wind

3. Indoor Unit Installation

3.1 Service space for indoor unit

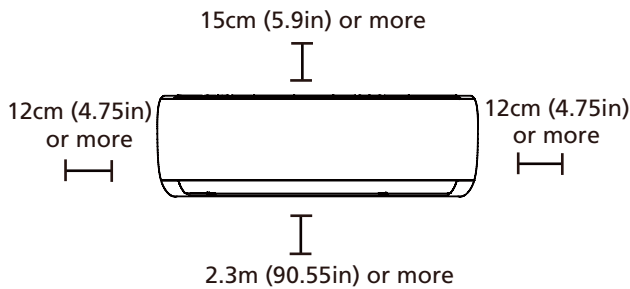

3.2 Attach mounting plate to wall

- The mounting plate is the device on which you will mount the indoor unit.

1. Remove the screw that attaches the mounting plate to the back of the indoor unit.

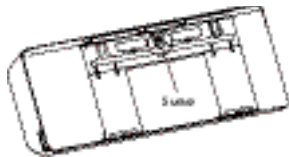

2. Place the mounting plate against the wall in a location that meets the standards in the Select Installation Location step. (See Mounting Plate Dimensions for detailed information on mounting plate sizes.)

3. Drill holes for mounting screws in places that:

- have studs and can support the weight of the unit.
- correspond to screw holes in the mounting plate.

4. Secure the mounting plate to the wall with the screws provided.

5. Make sure that mounting plate is flat against the wall.

- Mounting plate dimensions

Different models have different mounting plates. For the different customization requirements, the shape of the mounting plate may be slightly different. But the installation dimensions are the same for the same size of indoor unit.

Correct orientation of Mounting Plate

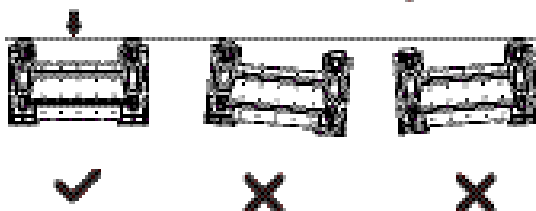

MSAGAU-09HRFNX-QRD0GW

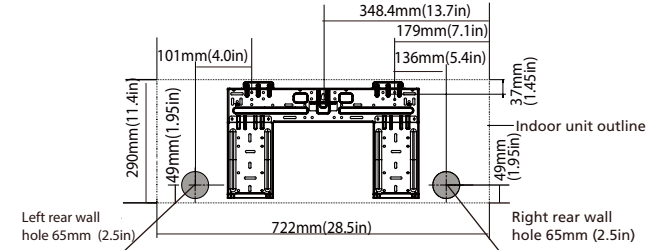

MSAGBU-09HRFN8-QRD1GW(GA), MSAGBU-12HRFNX-QRD0GW

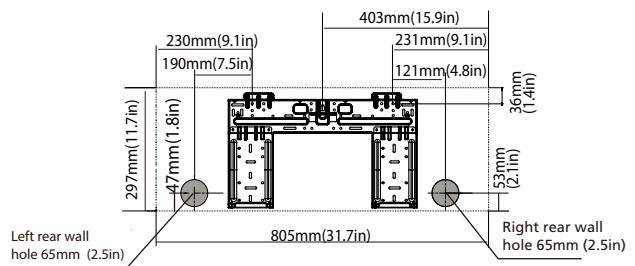

MSAGCU-18HRFNX-QRD0GW

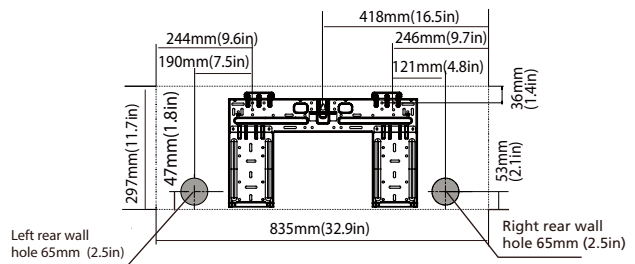

MSAGDU-24HRFN8-QRD0GW

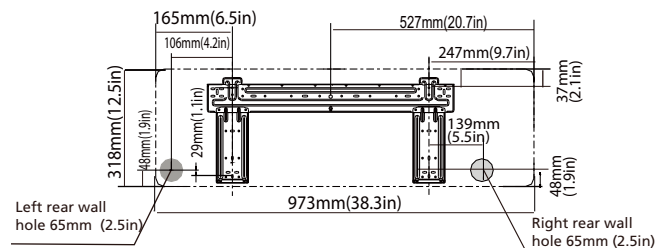

- Note for concrete or brick walls:

If the wall is made of brick, concrete, or similar material, drill 5mm-diameter (0.2in-diameter) holes in the wall and insert the sleeve anchors provided. Then secure the mounting plate to the wall by tightening the screws directly into the clip anchors.

3.3 Drill wall hole for connective piping

You must drill a hole in the wall for refrigerant piping, the drainage pipe, and the signal cable that will connect the indoor and outdoor units.

1. Determine the location of the wall hole based on the

position of the mounting plate. Refer to Mounting Plate Dimensions.

2. Using a 65mm (2.5in) or 90mm(3.54in) (depending on models)core drill, drill a hole in the wall. Make sure that the hole is drilled at a slight downward angle, so that the outdoor end of the hole is lower than the indoor end by about 5mm to 7mm (0.2-0.27in). This will ensure proper water drainage.

3. Place the protective wall cuff in the hole. This protects the edges of the hole and will help seal it when you finish the installation process.

NOTE: When drilling the wall hole, make sure to avoid wires, plumbing, and other sensitive components.

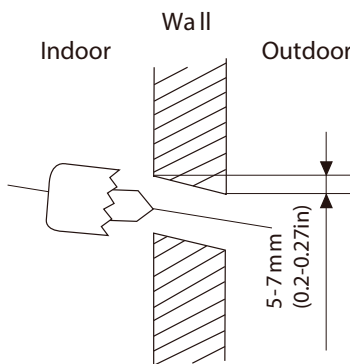

3.4 Prepare refrigerant piping

The refrigerant piping is inside an insulating sleeve attached to the back of the unit. You must prepare the piping before passing it through the hole in the wall.

1. Based on the position of the wall hole relative to the mounting plate, choose the side from which the piping will exit the unit.
2. If the wall hole is behind the unit, keep the knock-out panel in place. If the wall hole is to the side of the indoor unit, remove the plastic knock-out panel from that side of the unit.

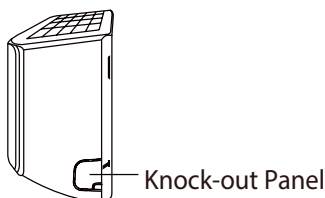

3. If existing connective piping is already embedded in the wall, proceed directly to the Connect Drain Hose step. If there is no embedded piping, connect the indoor unit's refrigerant piping to the connective piping that will join the indoor and outdoor units. Refer to the Refrigerant Piping Connection section of this manual for detailed instructions.

NOTE: Refrigerant piping can exit the indoor unit from

four different angles:

- Left-hand side
- Left rear
- Right-hand side
- Right rear

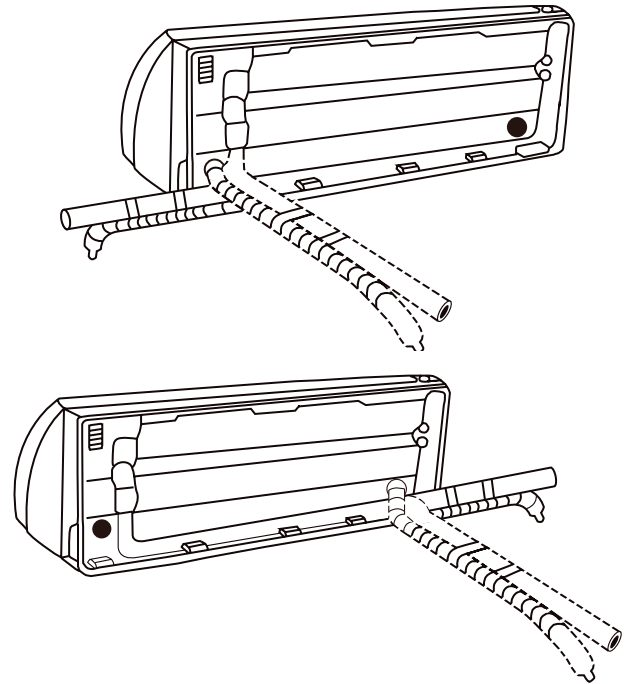

Be extremely careful not to dent or damage the piping while bending them away from the unit. Any dents in the piping will affect the unit's performance.

3.5 Connect drain hose

By default, the drain hose is attached to the left hand side of unit (when you're facing the back of the unit).

- Wrap the connection point firmly with Teflon tape to ensure a good seal and to prevent leaks.
- Remove the air filter and pour a small amount of water into the drain pan to make sure that water flows from the unit smoothly.

NOTE ON DRAIN HOSE PLACEMENT:

- Make sure to arrange the drain hose according to the following figures.

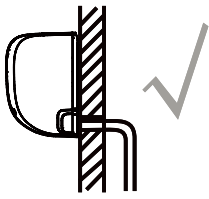

CORRECT

Make sure there are no kinks or dent in drain hose to ensure proper drainage.

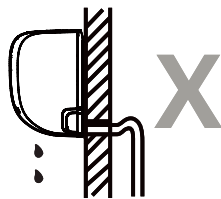

NOT CORRECT

Kinks in the drain hose will create water traps.

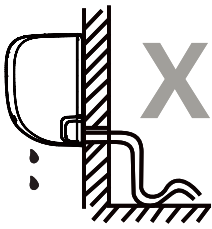

NOT CORRECT

Kinks in the drain hose will create water traps.

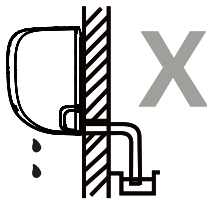

NOT CORRECT

Do not place the end of the drain hose in water or in containers that collect water. This will prevent proper drainage.

PLUG THE UNUSED DRAIN HOLE

To prevent unwanted leaks you must plug the unused drain hole with the rubber plug provided.

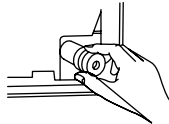

3.6 Connect signal and power cable

3.6.1 Before performing electrical work, read these regulations

1. All wiring must comply with local and national electrical codes, and must be installed by a licensed electrician.
2. All electrical connections must be made according to the Electrical Connection Diagram located on the panels of the indoor and outdoor units.
3. If there is a serious safety issue with the power supply, stop work immediately. Explain your reasoning to the client, and refuse to install the unit until the safety issue is properly resolved.
4. Power voltage should be within 90-110% of rated voltage. Insufficient power supply can cause malfunction, electrical shock, or fire.
5. If connecting power to fixed wiring, install a surge protector and main power switch with a capacity of 1.5 times the maximum current of the unit.
6. If connecting power to fixed wiring, a switch or circuit breaker that disconnects all poles and has a contact separation of at least 1/8in (3mm) must be incorporated in the fixed wiring. The qualified technician must use an approved circuit breaker or switch.
7. Only connect the unit to an individual branch circuit outlet. Do not connect another appliance to that outlet.
8. Make sure to properly ground the air conditioner.
9. Every wire must be firmly connected. Loose wiring can cause the terminal to overheat, resulting in product malfunction and possible fire.
10. Do not let wires touch or rest against refrigerant tubing, the compressor, or any moving parts within the unit.
11. If the unit has an auxiliary electric heater, it must be installed at least 1 meter (40in) away from any combustible materials.
12. BEFORE PERFORMING ANY ELECTRICAL OR WIRING WORK, TURN OFF THE MAIN POWER TO THE SYSTEM.

3.6.2 Connect signal and power cable

The signal cable enables communication between the indoor and outdoor units. You must first choose the right cable size before preparing it for connection.

Cable Types:

- Indoor Power Cable (if applicable): H05VV-F or H05V2V2-F
- Outdoor Power Cable: H07RN-F

- Signal Cable: H07RN-F

Table: Minimum Cross-Sectional Area of Power and Signal Cables

| Rated Current of Appliance (A) | Nominal Cross-Sectional Area (mm ²) |
|--------------------------------|---|
| > 3 and ≤ 6 | 0.75 |
| > 6 and ≤ 10 | 1 |
| > 10 and ≤ 16 | 1.5 |
| > 16 and ≤ 25 | 2.5 |
| > 25 and ≤ 32 | 4 |
| > 32 and ≤ 40 | 6 |

1. Prepare the cable for connection:

- Using wire strippers, strip the rubber jacket from both ends of signal cable to reveal about 40mm (1.57in) of the wires inside.
- Strip the insulation from the ends of the wires.
- Using wire crimper, crimp u-type lugs on the ends of the wires.

2. Open front panel of the indoor unit.

3. Using a screwdriver, open the wire box cover on the right side of the unit. This will reveal the terminal block.

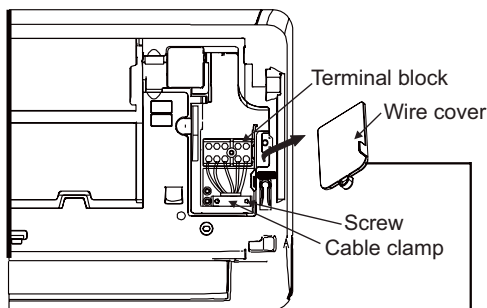

The Wiring Diagram is located on the inside of the indoor unit's wire cover.

4. Unscrew the cable clamp below the terminal block and place it to the side.

5. Facing the back of the unit, remove the plastic panel on the bottom left-hand side.

6. Feed the signal wire through this slot, from the back of the unit to the front.

7. Facing the front of the unit, match the wire colors with the labels on the terminal block, connect the u-lug and and firmly screw each wire to its corresponding terminal.

8. After checking to make sure every connection is secure,

use the cable clamp to fasten the signal cable to the unit. Screw the cable clamp down tightly.

9. Replace the wire cover on the front of the unit, and the plastic panel on the back.

NOTE:

- Choose the right cable size

The size of the power supply cable, signal cable, fuse, and switch needed is determined by the maximum current of the unit. The maximum current is indicated on the nameplate located on the side panel of the unit. Refer to this nameplate to choose the right cable, fuse, or switch.

- Take note of fuse specifications

The air conditioner's circuit board (PCB) is designed with a fuse to provide overcurrent protection. The specifications of the fuse are printed on the circuit board, such as: T3.15A/250VAC, T5A/250VAC, etc.

- Pay attention to live wire

While crimping wires, make sure you clearly distinguish the Live ("L") Wire from other wires.

- All wiring must performed strictly in accordance with the wiring diagram located on the back of the indoor units front panel.

- Do not mix up live and null wires.

This is dangerous, and can cause the air conditioning unit to malfunction.

- The wiring connection process may differ slightly between units.

3.7 Wrap piping and cables

Before passing the piping, drain hose, and the signal cable through the wall hole, you must bundle them together to save space, protect them, and insulate them.

1. Bundle the drain hose, refrigerant pipes, and signal cable according to the picture below:

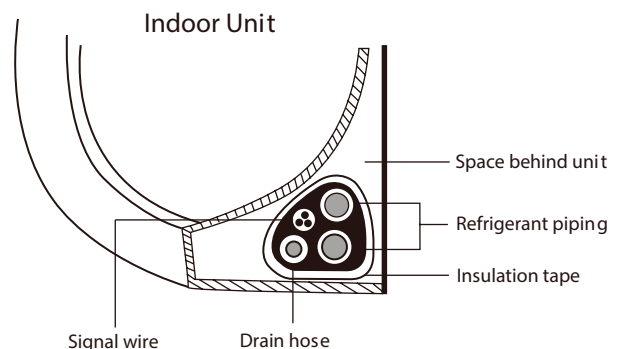

2. Using adhesive vinyl tape, attach the drain hose to the underside of the refrigerant pipes.

3. Using insulation tape, wrap the signal wire, refrigerant pipes, and drain hose tightly together. Double-check that all items are bundled in accordance with the picture above.

NOTE:

- Drain hose must be on bottom

Make sure that the drain hose is at the bottom of the bundle. Putting the drain hose at the top of the bundle can cause the drain pan to overflow, which can lead to fire or water damage.

- Do not intertwine signal cable with other wires

While bundling these items together, do not intertwine or cross the signal cable with any other wiring

- Do not wrap ends of piping

When wrapping the bundle, keep the ends of the piping unwrapped. You need to access them to test for leaks at the end of the installation process.

3.8 Mount indoor unit

3.8.1 If you installed new connective piping to the outdoor unit, do the following:

1. If you have already passed the refrigerant piping through the hole in the wall, proceed to Prepare refrigerant piping.
2. Otherwise, double-check that the ends of the refrigerant pipes are sealed to prevent dirt or foreign materials from entering the pipes.
3. Slowly pass the wrapped bundle of refrigerant pipes, drain hose, and signal wire through the hole in the wall.
4. Hook the top of the indoor unit on the upper hook of the mounting plate.
5. Check that unit is hooked firmly on mounting by applying slight pressure to the left and right-hand sides of the unit. The unit should not jiggle or shift.
6. Using even pressure, push down on the bottom half of the unit. Keep pushing down until the unit snaps onto the hooks along the bottom of the mounting plate.
7. Again, check that the unit is firmly mounted by applying slight pressure to the left and the right-hand sides of the unit.

3.8.2 If refrigerant piping is already embedded in the wall, do the following:

1. Hook the top of the indoor unit on the upper hook of the mounting plate.
2. Use the holder in the mounting plate to prop up the unit, giving you enough room to connect the refrigerant

piping, signal cable, and drain hose.

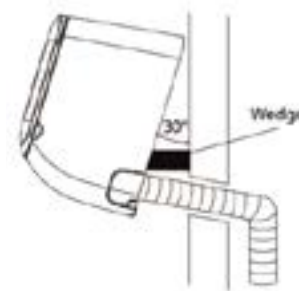

3. Connect drain hose and refrigerant piping (refer to Refrigerant Piping Connection section of this manual for instructions).

4. Keep pipe connection point exposed to perform the leak test (refer to Electrical Checks and Leak Checks section of this manual).

5. After the leak test, wrap the connection point with insulation tape.

6. Remove the bracket or wedge that is propping up the unit.

7. Using even pressure, push down on the bottom half of the unit. Keep pushing down until the unit snaps onto the hooks along the bottom of the mounting plate.

NOTE:

- Unit is adjustable

Keep in mind that the hooks on the mounting plate are smaller than the holes on the back of the unit. If you find that you don't have ample room to connect embedded pipes to the indoor unit, the unit can be adjusted left or right by about 30-50mm (1.25-1.95in), depending on the model.

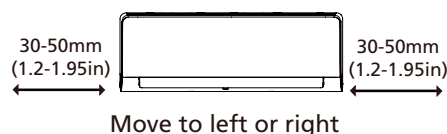

4. Outdoor unit installation(Side Discharge Unit)

4.1 Service space for outdoor unit

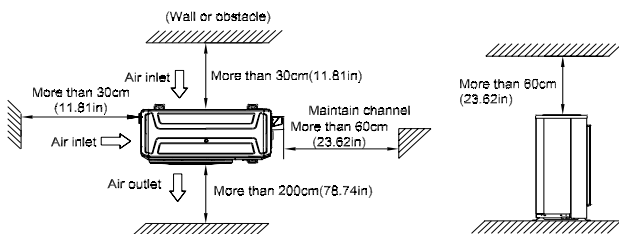

4.2 Bolt pitch

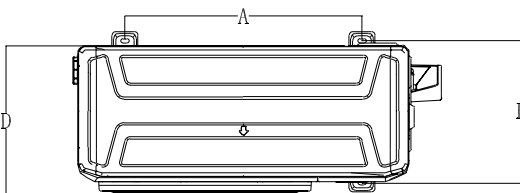

| Model | unit | A | B | D |
|--------------|------|------|------|------|
| 38QHG007D8S* | mm | 452 | 255 | 270 |
| 38QHG009D8S* | inch | 17.8 | 10 | 10.6 |
| 38QHG012D8S* | mm | 452 | 286 | 303 |
| 38QHG009D8SH | inch | 17.8 | 11.3 | 11.9 |
| 38QHG012D8SH | mm | 511 | 317 | 330 |
| 38QHG018D8S* | inch | 20.1 | 12.5 | 13 |
| 38QHG022D8S* | mm | 663 | 354 | 342 |
| 38QHG024D8S* | inch | 26.1 | 13.9 | 13.5 |

4.3 Install Outdoor Unit

Fix the outdoor unit with anchor bolts(M10)

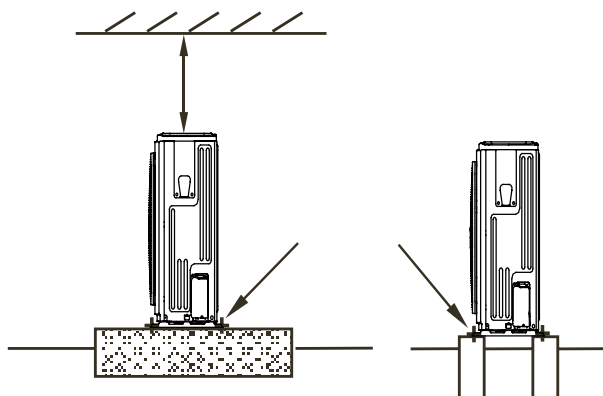

Cation

Since the gravity center of the unit is not at its physical center, so please be careful when lifting it with a sling.

Never hold the inlet of the outdoor unit to prevent it from deforming.

Do not touch the fan with hands or other objects.

Do not lean it more than 45°, and do not lay it sidelong.

Make concrete foundation according to the specifications of the outdoor units.

Fasten the feet of this unit with bolts firmly to prevent it from collapsing in case of earthquake or strong wind.

4.4 Install drain joint

Heat pump units require a drain joint. Before bolting the outdoor unit in place, you must install the drain joint at the bottom of the unit. Note that there are two different types of drain joints depending on the type of outdoor unit.

- If the drain joint comes with a rubber seal (see Fig. A), do the following:

1. Fit the rubber seal on the end of the drain joint that will connect to the outdoor unit.
2. Insert the drain joint into the hole in the base pan of the unit.
3. Rotate the drain joint 90° until it clicks in place facing the front of the unit.
4. Connect a drain hose extension (not included) to the drain joint to redirect water from the unit during heating mode.

- If the drain joint doesn't come with a rubber seal (see Fig. B), do the following:

1. Insert the drain joint into the hole in the base pan of the unit. The drain joint will click in place.
2. Connect a drain hose extension (not included) to the drain joint to redirect water from the unit during heating mode.

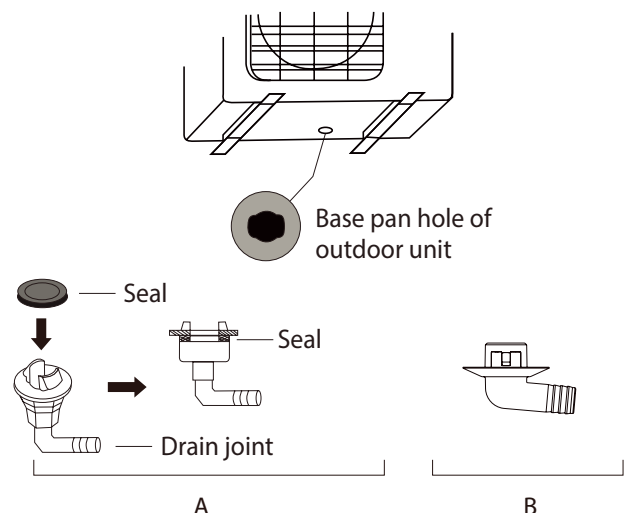

5. Refrigerant Pipe Installation

5.1 Maximum length and drop height

Ensure that the length of the refrigerant pipe, the number of bends, and the drop height between the indoor and outdoor units meets the requirements shown in the following table.

| Capacity(kBtu/h) | Max. Length (m/ft) | Max. Elevation (m/ft) |
|------------------|--------------------|-----------------------|
| 7~12 | 25/82 | 10/33 |
| 18~24 | 30/98.5 | 20/66 |

caution:

- The capacity test is based on the standard length and the maximum permissible length is based on the system reliability.
- Oil traps

If the indoor unit is installed higher than the outdoor unit:

-If oil flows back into the outdoor unit's compressor, this might cause liquid compression or deterioration of oil return. Oil traps in the rising gas piping can prevent this.

An oil trap should be installed every 10m(32.8ft) of vertical suction line riser.

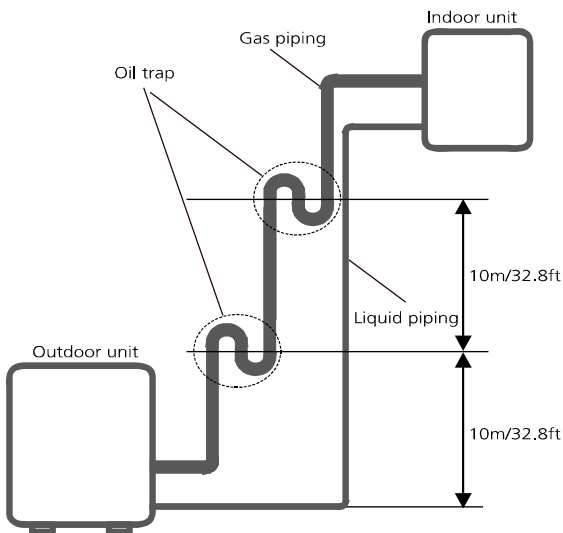

The indoor unit is installed higher than the outdoor unit

If the outdoor unit is installed higher than the indoor unit:

-It is recommended that vertical suction risers not be upsized. Proper oil return to the compressor should be maintained with suction gas velocity. If velocities drop below 7.62m/s(1500fpm (feet per minute)), oil return will be decreased. An oil trap should be installed every 6m(20ft) of vertical suction line riser.

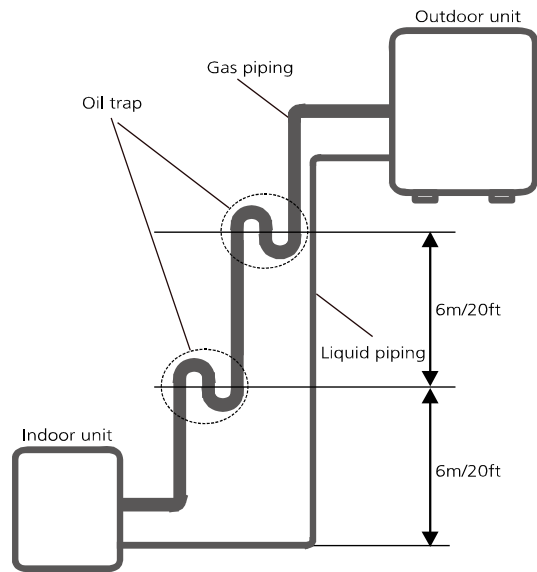

The outdoor unit is installed higher than the indoor unit.

5.2 The procedure of connecting pipes

1. Choose the pipe size according to the specification table.
2. Confirm the cross way of the pipes.
3. Measure the necessary pipe length.
4. Cut the selected pipe with pipe cutter
 - Make the section flat and smooth.

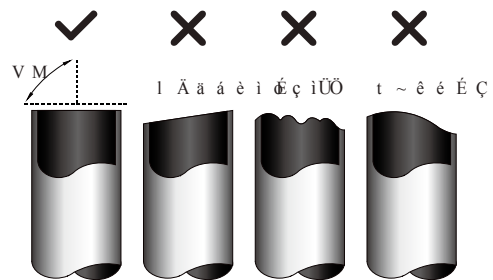

5. Insulate the copper pipe

- Before test operation, the joint parts should not be heat insulated.

6. Flare the pipe

- Insert a flare nut into the pipe before flaring the pipe
- According to the following table to flare the pipe.

| Outer diameter of pipe (inch(mm)) | A (mm/inch) | |
|--------------------------------------|-------------|-----------|
| | Min | Max |
| 1/4" (6.35) | 0.7/0.0275 | 1.3/0.05 |
| 3/8" (9.52) | 1.0/0.04 | 1.6/0.063 |
| 1/2" (12.7) | 1.0/0.04 | 1.8/0.07 |
| 5/8" (15.9) | 2.0/0.078 | 2.2/0.086 |
| 3/4" (19) | 2.0/0.078 | 2.4/0.094 |

- After flared the pipe, the opening part must be seal by end cover or adhesive tape to avoid duct or exogenous impurity come into the pipe.

7. Drill holes if the pipes need to pass the wall.

8. According to the field condition to bend the pipes so that it can pass the wall smoothly.

9. Bind and wrap the wire together with the insulated pipe if necessary.

10. Set the wall conduit

11. Set the supporter for the pipe.

12. Locate the pipe and fix it by supporter

- For horizontal refrigerant pipe, the distance between supporters should not be exceed 1m.
- For vertical refrigerant pipe, the distance between supporters should not be exceed 1.5m.

13. Connect the pipe to indoor unit and outdoor unit by using two spanners.

- Be sure to use two spanners and proper torque to fasten the nut, too large torque will damage the bellmouthing, and too small torque may cause leakage. Refer the following table for different pipe connection.

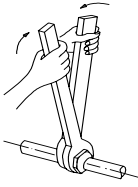
| Pipe Diameter | Torque | Sketch map |
|---------------|------------------------|---|
| | N.m(lb.ft) | |
| 1/4" (6.35) | 15~16 (11~11.8) |  |
| 3/8" (9.52) | 25~26 (18.4~19.18) | |
| 1/2" (12.7) | 35~36 (25.8~26.55) | |
| 5/8" (15.9) | 45~47 (33.19~34.67) | |
| 3/4" (19) | 65~67 (47.94~49.42) | |

6. Vacuum Drying and Leakage Checking

6.1 Purpose of vacuum drying

- Eliminating moisture in system to prevent the phenomena of ice-blockage and copper oxidation.

Ice-blockage shall cause abnormal operation of system, while copper oxide shall damage

compressor.

- Eliminating the non-condensable gas (air) in system to prevent the components oxidizing, pressure fluctuation and bad heat exchange during the operation of system.

6.2 Selection of vacuum pump

- The ultimate vacuum degree of vacuum pump shall be -756mmHg or above.
- Precision of vacuum pump shall reach 0.02mmHg or above.

6.3 Operation procedure for vacuum drying

Due to different construction environment, two kinds of vacuum drying ways could be chosen, namely ordinary vacuum drying and special vacuum drying.

6.3.1 Ordinary vacuum drying

1. When conduct first vacuum drying, connect pressure gauge to the infusing mouth of gas pipe and liquid pipe, and keep vacuum pump running for 1hour (vacuum degree of vacuum pump shall be reached -755mmHg).

2. If the vacuum degree of vacuum pump could not reach -755mmHg after 1 hour of drying, it indicates that there is moisture or leakage in pipeline system and need to go on with drying for half an hour.

3. If the vacuum degree of vacuum pump still could not reach -755mmHg after 1.5 hours of drying, check whether there is leakage source.

4. Leakage test: After the vacuum degree reaches -755mmHg, stop vacuum drying and keep the pressure for 1 hour. If the indicator of vacuum gauge does not go up, it is qualified. If going up, it indicates that there is moisture or leak source.

6.3.2 Special vacuum drying

The special vacuum drying method shall be adopted when:

1. Finding moisture during flushing refrigerant pipe.
2. Conducting construction on rainy day, because rain

water might penetrated into pipeline.

3. Construction period is long, and rain water might penetrated into pipeline.

4. Rain water might penetrate into pipeline during construction.

Procedures of special vacuum drying are as follows:

1. Vacuum drying for 1 hour.

2. Vacuum damage, filling nitrogen to reach 0.5Kgf/cm² .

Because nitrogen is dry gas, vacuum damage could achieve the effect of vacuum drying, but this method could not achieve drying thoroughly when there is too much moisture. Therefore, special attention shall be drawn to prevent the entering of water and the formation of condensate water.

3. Vacuum drying again for half an hour.

If the pressure reached -755mmHg, start to pressure leakage test. If it cannot reached the value, repeat vacuum damage and vacuum drying again for 1 hour.

4. Leakage test: After the vacuum degree reaches -755mmHg, stop vacuum drying and keep the pressure for 1 hour. If the indicator of vacuum gauge does not go up, it is qualified. If going up, it indicates that there is moisture or leak source.

7. Additional Refrigerant Charge

- After the vacuum drying process is carried out, the additional refrigerant charge process need to be performed.
- The outdoor unit is factory charged with refrigerant. The additional refrigerant charge volume is decided by the diameter and length of the liquid pipe between indoor and outdoor unit. Refer the following formula to calculate the charge volume.

| Diameter of liquid pipe (mm) | Formula |
|------------------------------|------------------------|
| 6.35 | $V=12g/m \times (L-5)$ |
| 9.52 | $V=24g/m \times (L-5)$ |

V: Additional refrigerant charge volume (g).

L : The length of the liquid pipe (m).

Note:

- Refrigerant may only be charged after performed the vacuum drying process.
- Always use gloves and glasses to protect your hands and eyes during the charge work.
- Use electronic scale or fluid infusion apparatus to weight refrigerant to be recharged. Be sure to avoid extra refrigerant charged, it may cause liquid hammer of the compressor or protections.
- Use supplementing flexible pipe to connect refrigerant cylinder, pressure gauge and outdoor unit. And The refrigerant should be charged in liquid state. Before recharging, The air in the flexible pipe and manifold gauge should be exhausted.
- After finished refrigerant recharge process, check whether there is refrigerant leakage at the connection joint part.(Using gas leakage detector or soap water to detect).

8. Electrical and Gas Leak Checks

8.1 Electrical Safety Checks

After installation, confirm that all electrical wiring is installed in accordance with local and national regulations, and according to the Installation Manual.

8.1.1 Before test run

- Check Grounding Work

Measure grounding resistance by visual detection and with grounding resistance tester. Grounding resistance must be less than 0.1 Ω .

Note: This may not be required for some locations in the US.

8.1.2 During test run

- Check for Electrical Leakage

During the Test Run, use an electroprobe and multimeter to perform a comprehensive electrical leakage test.

If electrical leakage is detected, turn off the unit immediately and call a licensed electrician to find and resolve the cause of the leakage.

Note: This may not be required for some locations in the US.

8.2 Gas Leak Checks

There are two different methods to check for gas leaks.

- Soap and Water Method

Using a soft brush, apply soapy water or liquid detergent to all pipe connection points on the indoor unit and outdoor unit. The presence of bubbles indicates a leak.

- Leak Detector Method

If using leak detector, refer to the device's operation manual for proper usage instructions.

8.3 After performing gas leak checks

After confirming that the all pipe connection points DO NOT leak, replace the valve cover on the outside unit.

9. Test Operation

9.1 Before test run:

Only perform test run after you have completed the following steps:

- Electrical Safety Checks – Confirm that the unit's electrical system is safe and operating properly
- Gas Leak Checks – Check all flare nut connections and confirm that the system is not leaking
- Confirm that gas and liquid (high and low pressure) valves are fully open

9.2 Test Run Instructions

You should perform the Test Run for at least 30 minutes.

1. Connect power to the unit.
2. Press the ON/OFF button on the remote controller to turn it on.
3. Press the MODE button to scroll through the following functions, one at a time:
 - COOL – Select lowest possible temperature
 - HEAT – Select highest possible temperature
4. Let each function run for 5 minutes, and perform the following checks:

| List of Checks to Perform | PASS/FALL | |
|--|------------|------------|
| No electrical leakage | | |
| Unit is properly grounded | | |
| All electrical terminals properly covered | | |
| Indoor and outdoor units are solidly installed | | |
| All pipe connection points do not leak | Outdoor(2) | Outdoor(2) |
| Water drains properly from drain hose | | |
| All piping is properly insulated | | |
| Unit performs COOL function properly | | |
| Unit performs HEAT function properly | | |
| Indoor unit louvers rotate properly | | |
| Indoor unit responds to remote controller | | |

5. After the Test Run is successfully completed, and you confirm that all checks points in List of Checks to Perform have PASSED, do the following:

- Using remote control, return unit to normal operating temperature.
- Using insulation tape, wrap the indoor refrigerant pipe connections that you left uncovered during the indoor unit installation process.

9.3 If ambient temperature is below 17°C (63°F)

You can't use the remote controller to turn on the COOL function when the ambient temperature is below 17°C. In this instance, you can use the MANUAL CONTROL button to test the COOL function.

1. Lift the front panel of the indoor unit, and raise it until it clicks in place.
2. The MANUAL CONTROL button is located on the right-hand side of the display box. Press it two times to select the COOL function.
3. Perform Test Run as normal.

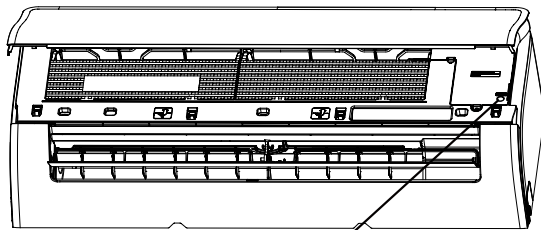

Manual control button